



Stimulus Generator STG5

USER MANUAL

Imprint

Information in this document is subject to change without notice. No part of this document may be reproduced or transmitted without the express written permission of Multi Channel Systems MCS GmbH.

While every precaution has been taken in the preparation of this document, the publisher and the author assume no responsibility for errors or omissions, or for damages resulting from the use of information contained in this document or from the use of programs and source code that may accompany it.

In no event shall the publisher and the author be liable for any loss of profit or any other commercial damage caused or alleged to have been caused directly or indirectly by this document.

© 2023 Multi Channel Systems MCS GmbH. All rights reserved.

Printed: 05.09.2023

Multi Channel Systems MCS GmbH

Aspenhaustraße 21
72770 Reutlingen

Germany

Phone +49-7121-909 25 - 0

Fax +49-7121-909 25 -11

sales@multichannelsystems.com

www.multichannelsystems.com

Microsoft and Windows are registered trademarks of Microsoft Corporation. Products that are referred to in this document may be either trademarks and/or registered trademarks of their respective holders and should be noted as such. The publisher and the author make no claim to these trademarks.

GENERAL INFORMATION

Important Safety Advice



Warning: Make sure to read the following advice prior to installation or use of the device and the software. If you do not fulfill all requirements stated below, this may lead to malfunctions or breakage of connected hardware, or even fatal injuries.



Warning: Always obey the rules of local regulations and laws. Only qualified personnel should be allowed to perform laboratory work. Work according to good laboratory practice to obtain best results and to minimize risks.



Warning: The device and the software are not intended for medical uses and must not be used on humans. MCS assumes no responsibility in any case of contravention.

The product has been built to the state of the art and in accordance with recognized safety engineering rules. The device may only

- be used for its intended purpose
- be used when in a perfect condition.

Improper use could lead to serious, even fatal injuries to the user or third parties and damage to the device itself or other material damage.

Malfunctions which could impair safety should be rectified immediately.

Grounding

This product is grounded through the grounding conductor on the power cord. To avoid electric shock, the grounding conductor must be connected to earth.

Orient the Equipment Properly

Do not orient the equipment so that it is difficult to manage the disconnection device.

High Voltage

Important: The STG5 has a compliance voltage of 70 V!

Electrical cords must be properly laid and installed. The length and quality of the cords must be in accordance with local provisions.

Only qualified technicians may work on the electrical system. It is essential that the accident prevention regulations and those of the employers' liability associations are observed.

Each time before starting up, make sure that the power supply agrees with the specifications of the product. Check the power cord for damage each time the site is changed. Damaged power cords should be replaced immediately and may never be reused. Check the leads for damage.

Damaged leads should be replaced immediately and may never be reused. Do not try to insert anything sharp or metallic into the vents or the case. Liquids may cause short circuits or other damage. Always keep the device and the power cords dry. Do not handle it with wet hands.

Requirements for the Installation

Make sure that the device is not exposed to direct sunlight. Do not place anything on top of the device, and do not place it on top of another heat producing device, so that the air can circulate freely.

Explanation of the Symbols used



Caution / Warning



DC, direct current

Guarantee and Liability

The general conditions of sale and delivery of Multi Channel Systems MCS GmbH always apply. They can be found online at <https://www.multichannelsystems.com/sites/multichannelsystems.com/files/documents/Terms%20and%20Conditions.pdf>

Multi Channel Systems MCS GmbH makes no guarantee as to the accuracy of any and all tests and data generated by the use of the device or the software. It is up to the user to use good laboratory practice to establish the validity of his / her findings.

Guarantee and liability claim in the event of injury or material damage are excluded when they are the result of one of the following:

- Improper use of the device.
- Improper installation, commissioning, operation or maintenance of the device.
- Operating the device when the safety and protective devices are defective and/or inoperable.
- Non-observance of the instructions in the manual regarding to transport, storage, installation, commissioning, operation or maintenance of the device.
- Unauthorized structural alterations to the device.
- Unauthorized modifications to the system settings.
- Inadequate monitoring of device components subject to wear.
- Improperly executed and unauthorized repairs.
- Unauthorized opening of the device or its components.
- Catastrophic events due to the effect of foreign bodies or acts of God.

Operator's Obligations

The operator is obliged to allow only persons to work on the device, who

- are familiar with the safety at work and accident prevention regulations and have been instructed how to use the device;
- are professionally qualified or have specialist knowledge and training and have received instruction in the use of the device;
- have read and understood the chapter on safety and the warning instructions in this manual and confirmed this with their signature.

It must be monitored at regular intervals that the operating personnel are working safely. Personnel still undergoing training may only work on the device under the supervision of an experienced person.

Terms of Use for MC_Stimulus III

You are free to use MC_Stimulus III for its intended purpose. You agree that you will not decompile, reverse engineer, or otherwise attempt to discover the source code of the software.

WELCOME TO THE STIMULUS GENERATOR 5

Product Overview

This manual includes the description of the MC_Stimulus III software for the new STG5 device as well as for the STG4000 series and for the STG3008-FA. Differences of the software in relation to the named devices are explicit noted.

Stimulus Generator STG5

The STG5 comprises a “Base” device for two output channels and up to three optional “Satellite” devices, each adding two additional output channels. The MC_Stimulus III software is used to control the device.



Stimulus generators of the fifth series are general purpose stimulators designed for a wide variety of applications, both *in vitro* and *in vivo*.

Flexible and easy-to-use MC_Stimulus III software enables complex stimulus waveforms in current and voltage mode. Waveforms designed in the program or imported from an external ASCII file are converted by the connected STGs into pulses, which are sent to stimulating electrodes.

Stimulus isolation units (SIU) for each channel are included. Thus, no external SIUs are required. Eight TTL trigger inputs and one TTL output per analog channel allow to synchronize the stimulus generator with other instruments. Triggering of other devices via programmable TTL pulses (Sync Out) is possible, as well as triggering of the STG by external devices via the Trigger In input. For example, you can synchronize stimulation and recording with a TTL signal sent from the Sync Out output of the STG to a data acquisition system.

Stimulus generators are available with two, four or eight completely independent stimulation channels. Each channel is freely programmable, combination of channels to achieve complex stimulation patterns is not necessary.

The real-time stimulus generator STG5 is a modular system, consisting of base device and satellite, that can send continuous pulse streams to stimulating electrodes. The base unit provides eight trigger inputs. Each module has two analog outputs and two sync outputs.

The STG5 operates in „Download“ mode.

In download mode, you can control the STG5 either by the MC_Stimulus III or by a custom program.

Stimulus protocols are created in MC_Stimulus III or the custom program; complete protocols are downloaded onto the STG5, and can after the download be executed without a computer connection.

To exchange data files between MC_Stimulus II and MC_Stimulus III, you must use the ASCII import and export.

SETTING UP THE STG5 HARDWARE: BASE AND SATELLITE DEVICES



Note: You can use a USB hub for connecting the STG5 „Base“ device to the computer, for example, if you have no free USB port or, if you need to extend the USB-C cable.

Provide a power supply and a computer with USB-C port in the immediate vicinity of the installation site. Make sure the STG5 „Base“ is switched off before you connect it to the power supply.

- Place the STG5 base device on a stable surface, where the air can circulate freely and the STG5 is not exposed to direct sunlight. (Base: 2.10 kg, Satellite: 1.44 kg)
- Connect the external power supply to the STG5.
- Connect the external power supply to the power outlet.
- Connect the USB-C connector to the USB-C port of the computer. The computer connection is necessary for programming the STG5, but not for operating it, except in “Batch” mode.
- Place the STG5 satellite device exactly on the STG5 base device. It is possible to mount up to 3 satellites on the STG5 base.
- Connect the base and satellite devices via „Daisy Chain Out“ connector of the base and the „Daisy Chain In“ connector of the satellite with a Lemo cable.



- Connect both devices via „Ground“ connectors to an appropriate ground input of the stimulation setup, for example, to the ground input of the amplifier.
- Connect the „Analog 1“ and „Analog 2“ BNC plugs of the required output channels with BNC cables to the stimulating electrodes. Current and voltage driven stimulation is software switchable and generated from the same outputs.
- (Optional) Connect the required „Trigger Inputs“ with BNC cables to instruments that produce TTL signals for triggering the STG5.
- (Optional) Connect the required „Sync Outputs“ with BNC cables to following instruments that you want to be triggered by TTL signals from the STG5. Please use the respective channels of the STG5 „Base“ first. Then use the channels of the satellites.
- Switch the STG5 on by pressing the toggle switch on the rear panel.

Note: It is recommended to start the STG5 ten minutes before use to allow warming up!

Driver Installation

The stimulus generator STG5 is a plug and play device. The driver is automatically installed together with the MC_Stimulus III program. The Windows operating system detects a new hardware when the stimulus generator is connected to the computer, if the program has not been installed beforehand.

Important: Please make sure that you have full control over your computer as an administrator. Otherwise, it is possible that the installed hardware does not work properly.

If there are any problems, and you need to install or update the driver manually, please see the MC_Stimulus III help for more information.

Installing the Software

System Requirements

Software: One of the following Microsoft Windows[®] operating systems is required: Windows 10, (32 or 64 Bit), (English and German versions supported).

Hardware: USB port

Please check the system requirements before you install the software. MCS cannot guarantee that the software works properly if these requirements are not fulfilled.

Important: Please make sure that you have full control over your computer as an administrator. Otherwise, it is possible that the installed software does not work properly.

Double-click "MC_Stimulus_III-1.x.0.exe" on the installation volume. The installation assistant will show up and guide you through the installation procedure. Follow the instructions of the installation assistant.

When you have finished the installation of the MC_Stimulus III software and the included driver, you can now operate the STG5.

MC_STIMULUS III SOFTWARE

The MC_Stimulus III software is created for stimulus generator systems of the newest generation, the STG5 but also for stimulus generators of the fourth and second series (STG400x, STG200x) as well as for the STG3008-FA.

Stimuli are created user friendly by entering the desired pulses (rectangular, ramp, or sine waveforms) into a worksheet. Waveforms can be combined freely to create virtually any stimulus pattern.

Created stimuli are displayed in a WYSIWYG stimulus display. All channels are set up separately.

For even more convenience, repetitive stimulus patterns do not have to be entered separately, but can be grouped and looped. You can also import waveforms in ASCII file format and use them for stimulation. You can print and save stimuli and comments for later use and documentation of your experiments.

Stimulus Protocol Worksheet

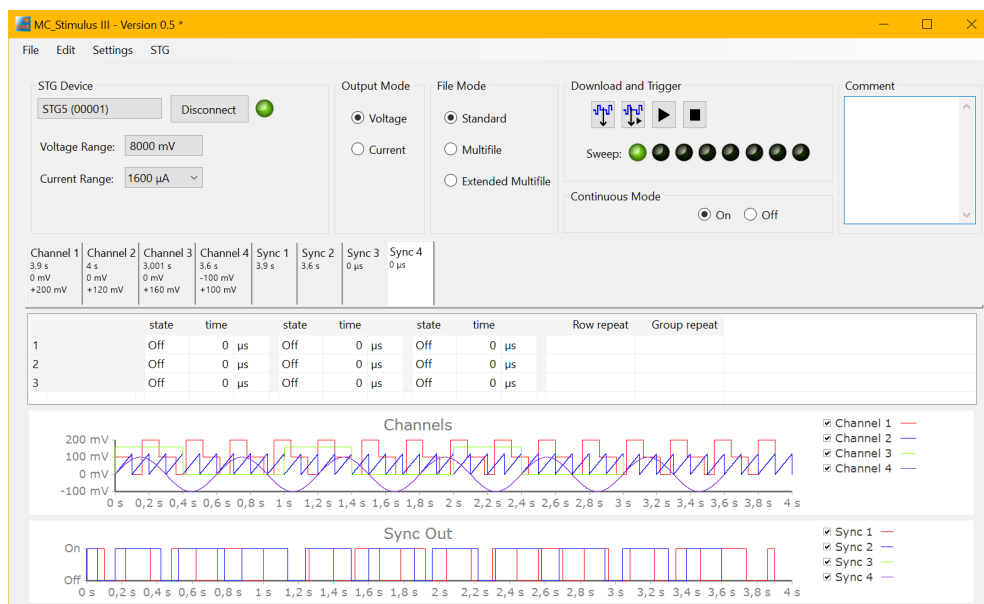

Operating the STG5



Warning: Make sure that you do not come in contact with the cables or the connectors of the STG5 after you have started the STG5. The high voltage and power can lead to injuries.



Warning: Do not start the STG5 if you are unsure about the channel configuration or the nature of the downloaded file.

Set up your Experiment

Switch the STG5 on.

Note: It is recommended to start the STG ten minutes before use to allow warming up!

1. Set up your stimuli with the MC_Stimulus III program.
2. Send the stimulus sequence from a MC_Stimulus III file to the STG5.
3. Start the STG5 either manually by pressing the „Start / Stop“ button on the front panel, with the software controls, or with an external trigger.

Creating Stimuli

Stimuli are created user friendly by entering the desired pulses, rectangular, ramp, or sine waveforms into a MC_Stimulus III worksheet. Waveforms can be combined freely to create virtually any stimulus pattern. Created stimuli are displayed in a WYSIWYG window.

Starting Stimulation

Note: You need a computer connection only when you are using the software controls for starting and stopping the stimulus generator. When you are using the STG5 interface or an external control (trigger, you can disconnect the stimulus generator from the computer and operate it independently. But you cannot remove the STG5 from the power connection. The memory is cleared when the STG5 has lost power.

After the download of the stimulus file on the STG5, you can start the stimulation. There are several ways to start the STG5.

The MC_Stimulus III Worksheet

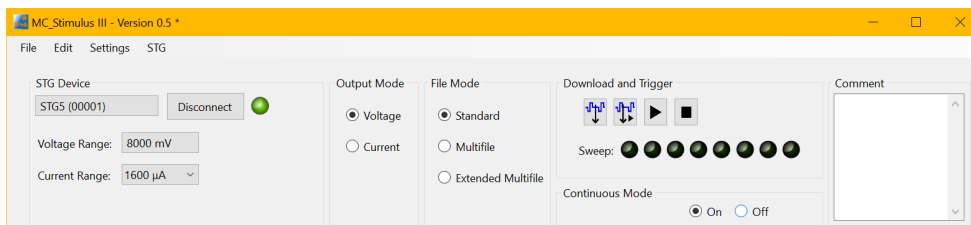

Windows in the Header of the GUI

STG Device

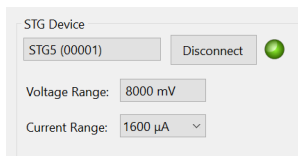

Select the respective STG5 from the drop down menu and press the "Connect" button. The LED lights up. "Voltage Range" and "Current Range" are displayed.

If you have more than one STG connected to the same computer, please select the actual device from the drop down menu.

- The serial number is printed on the STG's case. The serial number of the currently active STG5 is displayed on the status bar of the currently active instance of the MC_Stimulus III program.
- You can open multiple instances of the MC_Stimulus III program and control multiple STG5s at the same time. Please make sure that you control each STG5 only by one MC_Stimulus III instance.
- You can also open only one MC_Stimulus III instance and control multiple STG5s one after the other by the same instance. Simply change the settings in the „STG Device“ drop down and select the next STG5 when you have finished to program the first. The STG5s can be operated without a computer connection.

Output Mode

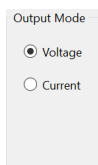

Select the output mode from the radio buttons "Voltage" and "Current".

When changing the “Output Mode”, the following dialog appears. Please decide whether to “Convert Data” from current to voltage or vice versa, or to “Delete all Channel Data”.

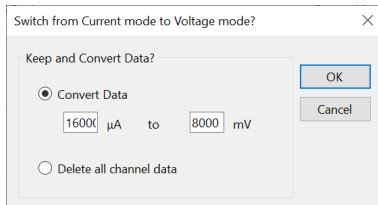

File Mode

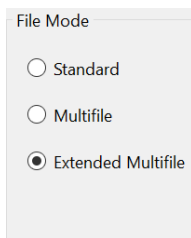

Select the file mode from the radio buttons: “Standard”, “Multifile” and “Extended Multifile”.

Download and Trigger

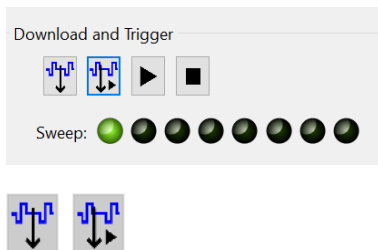

Click the button “Download” to download the stimulation patterns to the STG5 device or click the button “Download and Start”. You can start the stimulation directly after the download with the command “Download and Start” or also later with the command „Start“. You can stop stimulation with the command „Stop“. Starting the STG5 by using the „Start“ command is considered as activating all trigger inputs, that is, all channels are started, and all „Sync Out“ outputs are active. Likewise, all channels are stopped when you click „Stop“. You can start the stimulation after download on up to eight trigger separately.



Please use the combined LED / Start / Stop buttons. You can start and stop the stimulation manual whenever you want by clicking the corresponding LED / Start / Stop button. The LED indicates the status: Black means trigger off, red means trigger on. The first button on the left side belongs to trigger 1, the second button to trigger 2, and so on.

STG Interface: You can start the stimulation by pressing the „Start / Stop“ button on the front panel of the STG5 base device. Press the button again to stop the stimulation. Starting the STG5 by pressing the „Start / Stop“ button is considered as activating all trigger inputs, that is, all channels are started and stopped, and all Sync Out outputs are active when the STG5 is started. Pressing the „Start / Stop“ button stops the stimulation if at least one channel is still active in the moment of the trigger event, indicated by the lighting SWEEP LED. Pressing the button starts stimulation only if no channel is active, indicated by dark sweep LEDs.

External Control: You can start the stimulation on a trigger from an external device, for example, a switch. You can use up to eight trigger inputs that independently trigger the analog output channels that you have assigned to them. The trigger works in a similar way as when you press the „Start / Stop“ button. You can choose the action that will be taken when one of the channels that are assigned to the respective trigger input is still active. Either the stimulus protocols on the triggered channels are stopped or restarted; or the trigger event is ignored. There is also a separate „Sync Out“ output for each „Sync In“ trigger input. You can assign the sync outs to the trigger inputs. The default settings define that „Sync Out 1“ is active when „Sync In 1“ is triggered, and so on. Please see chapter „Trigger Settings“ for more details.

Continuous Mode

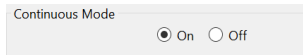

Switch the “Continuous Mode” via radio buttons “On” or “Off”.

Comment

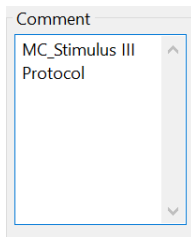

Status Control on the Front of the STG5 Base

Status Light	Color	Meaning
Power	Green	STG5 is switched on.
LED Ring around the Analog Outputs	Green	Voltage mode
	Blue	Current mode
	Red	Clipping of the output. The voltage needed to supply the programmed current in “Current Mode” exceeds the “Compliance Voltage.”
Sweep	Orange	Indicates the active trigger (up to eight, at least one trigger is active and running). Each stimulation channel can be assigned to any trigger. If all eight channels are assigned to trigger one for example, only one sweep indicator will light up, even though all stimulation channels can be active. See also “Triggering Stimulation”.



Voltage Mode



Current Mode



Clipping

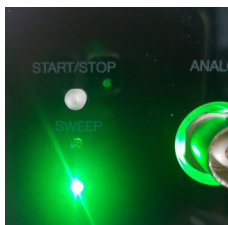

Power “On”

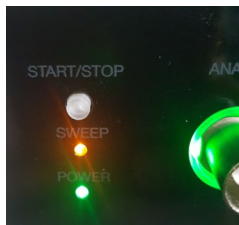

Sweep

File

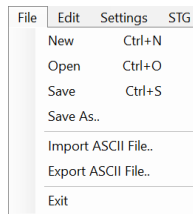

Menu to open and save files, to import and export ASCII files and to exit the software program.

Edit

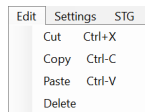

Menu to “Cut”, “Copy”, “Paste” and to “Delete” data.

Settings

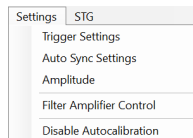

Menu to switch to the submenus “Trigger Settings”, “Auto Sync Settings” and “Amplitude”. Menu for “Filter Amplifier Control” and to “Disable Autocalibration”.

STG

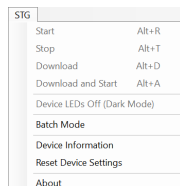

Menu to operate the STG5: Start and stop, download and download and start. If the LEDs on the front of the device should be off for light sensitive experiments, please use the “Dark Mode”. Activate the “Batch Mode” and find “Device Information”, “Reset the Device Settings” and “About”.

Device Information and About

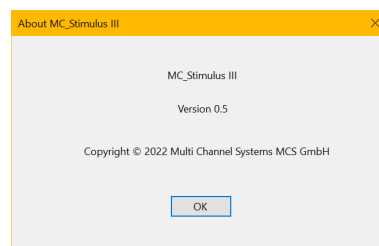
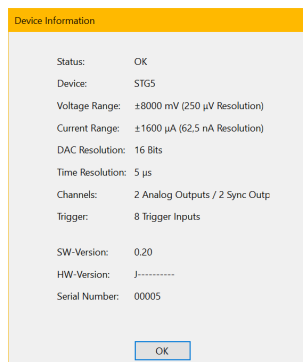

MC_STIMULUS III WORKSHEET

Channel 1	Channel 2	Channel 3	Channel 4	Channel 5	Channel 6	Channel 7	Channel 8	Sync 1	Sync 2	Sync 3	Sync 4	Sync 5	Sync 6	Sync 7	Sync 8
6.24 ms	5 ms	0 μs	0 μs	0 μs	0 μs	0 μs	0 μs	7.96 ms	7.64 ms	0 μs	0 μs	0 μs	0 μs	0 μs	0 μs
0 mV	0 mV	0 mV	0 mV	0 mV	0 mV	0 mV	0 mV	0 mV	0 mV	0 mV	0 mV	0 mV	0 mV	0 mV	0 mV
+15 mV	+6 mV	0 mV	0 mV	0 mV	0 mV	0 mV	0 mV	0 mV	0 mV	0 mV	0 mV	0 mV	0 mV	0 mV	0 mV

Pulse	value	time	value	time	value	time	Row repeat	Group repeat
1 Rectangular	10 mV	40 μs	15 mV	40 μs	10 mV	40 μs	3	2
2 Rectangular	15 mV	40 μs	10 mV	40 μs	15 mV	40 μs	5	5
3 Rectangular	0 mV	40 μs	5 mV	40 μs	5 mV	40 μs	3	7
4 Rectangular	0 mV	0 μs	0 mV	0 μs	0 mV	0 μs		
5 Rectangular	0 mV	0 μs	0 mV	0 μs	0 mV	0 μs		

You can freely combine any pulse types. Use a separate row for each pulse type.

Hint: Several tools are provided for editing whole columns at once or autocreating entries.

1. Select the desired output type first. Click either „Voltage“ or „Current“ in the „Output Mode“ window of MC_Stimulus III.

Note: In current mode, a protection switch disconnects the current source from the electrode, to avoid leak currents. The switch opens as soon as the stimulation pattern starts. To allow some time for the switch to open, it is recommended to start current pulses with a short period of 0 μA. 40 μs is sufficient.

2. Click „Channel 1“ tab to select an output channel. The according channel worksheet is highlighted in white.

3. Now you can enter the pulses into the worksheet. Select a „Pulse“ type, either rectangular, ramp, or sine.

4. Enter the desired voltage steps and a time length for each step. The according pulse is displayed in the WYSIWYG display at once.

Pulse Types

Three basic pulse types are available in MC_Stimulus III. You can create virtually any pulse by combining different types.

- Rectangular
- Ramp
- Sine wave

Note: The time resolution is 5 μs. When you enter time steps that are not a multiple of 20 μs, the length of the step is internally adjusted (rounded arithmetically, that is, 249 μs would be rounded down to 240 μs, 250 would be rounded up to 260 μs) to a valid value.

The minimum voltage resolution is 250 μV, the current resolution is 6,25 nA, 62.5 nA or 625 nA, in dependency of the selected current range.

Please regard also the minimum and maximum output voltage / current of your STG5 version. If you enter voltage or current values outside the STG's limit, the invalid value will be changed automatically when you download the protocol. Cells with changed values will be highlighted in yellow.

Note: If you work near the resolution limits of the STG5, the output pulses may differ from the programmed pulses. In this case, you should check the output with an oscilloscope. Please see also the "Analog Output Signals" chapter.

Pulse	value	time
1 Rectangular	10 mV	30 μs
2 Rectangular	15 mV	40 μs

Please note that the memory of the STG5 is limited (64 MB). You will get an error message if the memory is full.

For the digital „Sync“ channels, only TTL pulses with bit patterns of 0 „Off“ and 1 „On“ can be programmed. A logical state of 1 „On“ results in a 3.3 V output signal, and a logical state of 0 „Off“ results in a 0 V output. Please see also the "Triggering Stimulation" chapter.

Rectangular Pulse Type

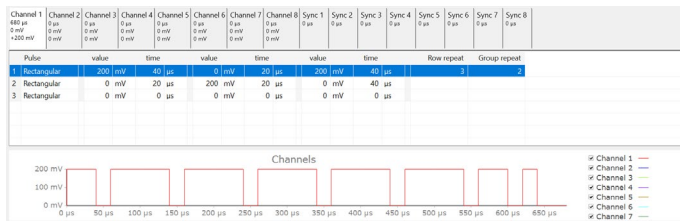

Enter each voltage / current level and the duration of the pulse. The voltage / current jumps directly to the specified level. In one row, you can enter up to three voltage / current levels. Use the next row for programming more levels.

Ramp Pulse Type

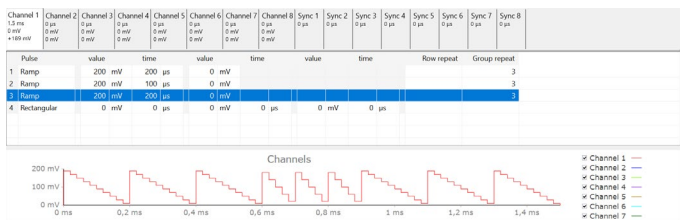

Define the starting point, end point, and the length of the ramp. The ramp is then built according to these parameters in small single steps of 20 μ s.

Sine Wave Pulse Type

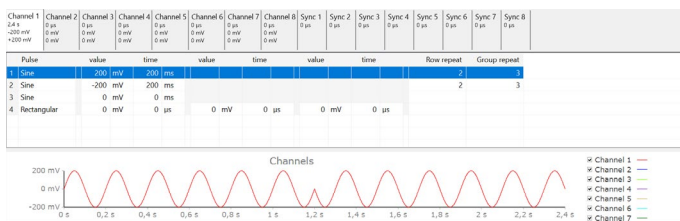

Define the amplitude and the period of the sine wave. The sine wave is then computed according to these parameters with a minimum resolution of 1 mV and 20 μ s. If you enter a negative amplitude, the sine wave starts with its negative alternation.

Autorepeating Pulses and Protocols

For entering complex stimuli easier and faster, you can repeat rows and groups instead of entering the pulses several times into the worksheet. You can repeat each single row. In the preceding example, the rectangular pulse in row 1 is repeated twice. You can also group several rows and repeat them altogether.

Repeating Rows

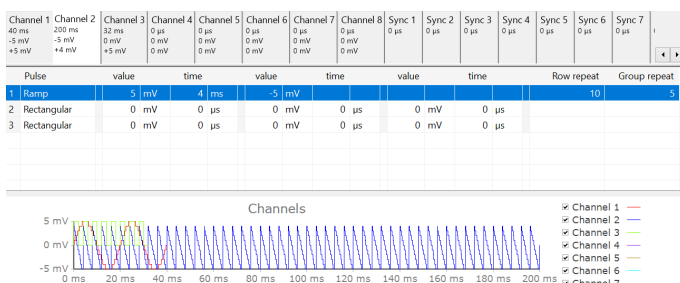

Type the number of repeats into the Row Repeat cell of the appropriate row. The pulses of the complete row are repeated the specified number of times.

Grouping and Repeating Groups

1. Select several cells by clicking and dragging cells in the „Group Repeat“ column. Selected cells are highlighted in blue.
2. Point to the selected cells and right click to open the context menu.
3. Click „Group / Ungroup“. The corresponding rows are grouped now. This is indicated by a merging of the „Group Repeat“ cells.

Pulse	value	time	value	time	value	time	Row repeat	Group repeat
1 Ramp	5 mV	4 ms	-5 mV				10	3
2 Rectangular	0 mV	0 µs	0 mV	0 µs	0 mV	0 µs	3	3
3 Rectangular	0 mV	0 µs	0 mV	0 µs	0 mV	0 µs	5	3
4 Rectangular	0 mV	0 µs	0 mV	0 µs	0 mV	0 µs		
5 Rectangular	0 mV	0 µs	0 mV	0 µs	0 mV	0 µs		

4. Type the number of repeats into the merged „Group Repeat“ cell.

Repeating complete pulse protocols (autorepeat function), Continuous Mode

Continuous Mode On Off

You can repeat the complete stimulus on all output channels that are triggered by the same trigger. This means, each time when a trigger event occurs, the complete stimuli on all corresponding output channels are repeated for the specified number of times. If the stimuli have different lengths, the starting points are synchronized. For example, if channel 1 has a stimulus with a length of 500 ms, and channel 2 of 1000 ms, and both are triggered by the same trigger event, channel 1 waits 500 ms for the repeat until the output stream of channel 2 has been finished.

Note: The Sync Out signal for the corresponding trigger is repeated as well, each time the stimulus is repeated.

Hint: You can repeat the complete stimulus protocol that is assigned to a trigger continuously by using the „Continuous Mode“ setting. Continuous mode can be activated in the main window. The STG5 has then to be stopped manually by the user. You can use this feature regardless whether you use an external trigger input or not. When you press the „Start“ button, this is considered as if all trigger inputs were active.

When you use „Continuous Mode“, the repeats entered in the „Trigger Settings“ dialog box are disabled.

Trigger Settings

Settings | STG

- Trigger Settings
- Auto Sync Settings
- Amplitude
- Filter Amplifier Control
- Disable Autocalibration

Click option „Trigger Settings“ in the „Settings“ menu. The „Trigger Settings“ dialog opens.

Enter the number of repeats for each trigger separately. 0 repeats the output signals continuously.

TriggerSettings

Settings

	Ch1	Ch2	Ch3	Ch4	Ch5	Ch6	Ch7	Ch8	S1	S2	S3	S4	S5	S6	S7	S8	Repeat
Trigger1	<input type="radio"/>	<input type="radio"/>							<input checked="" type="radio"/>	<input checked="" type="radio"/>							2
Trigger2	<input type="radio"/>	<input type="radio"/>							<input type="radio"/>	<input type="radio"/>							4
Trigger3	<input checked="" type="radio"/>	<input checked="" type="radio"/>							<input type="radio"/>	<input type="radio"/>							0
Trigger4	<input type="radio"/>	<input type="radio"/>							<input type="radio"/>	<input type="radio"/>							1
Trigger5	<input type="radio"/>	<input type="radio"/>							<input type="radio"/>	<input type="radio"/>							1
Trigger6	<input type="radio"/>	<input type="radio"/>							<input type="radio"/>	<input type="radio"/>							1
Trigger7	<input type="radio"/>	<input type="radio"/>							<input type="radio"/>	<input type="radio"/>							1
Trigger8	<input type="radio"/>	<input type="radio"/>							<input type="radio"/>	<input type="radio"/>							1

Trigger event while sweeping

Stop Restart Ignore Trigger as Gate Single Trigger

Repeating complete pulse protocols, Gating Trigger

Repeated stimulation of complete protocols can also be controlled by a gating trigger. Channels associated with a Trigger input will be active as long as the condition of that Trigger is 1 (HIGH) and switched off as soon as the condition becomes 0 (LOW). Gating trigger function can be enabled in the Trigger Settings menu.

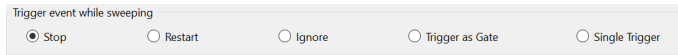

Auto Sync Settings for Autocreating Trigger Pulses

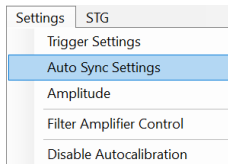

Click option "Auto Sync Settings" in the "Settings" menu. The "Auto Sync Settings" dialog opens.

If you want to synchronize other devices with the stimulus generator, you have to set up the digital output of the Sync Out channels in synchrony to the stimulus pulses. This may sometimes be a bit tricky and time consuming, especially for complex stimulus protocols.

The „Auto Sync“ feature is intended for making the work with MC_Stimulus III more efficient: Digital Sync Out TTL pulses synchronous to stimulus pulses are generated automatically by this feature. Each time an analog channel generates a pulse (that is, its value is not equal to zero), the logical state of the assigned Sync Out channel is set to HIGH (=1). You can set the time offset of the TTL's rising edge before the stimulus pulse and of the TTL's falling edge after the pulse. If you change the stimulus protocol, corresponding „Auto Sync“ pulses are updated on the fly. This feature is especially recommended for controlling the MEA1060-BC amplifier with superior stimulus artifact suppression.

1. On the „Settings“ menu, click „Auto Sync Settings“. The „Auto Sync Settings“ dialog box appears.

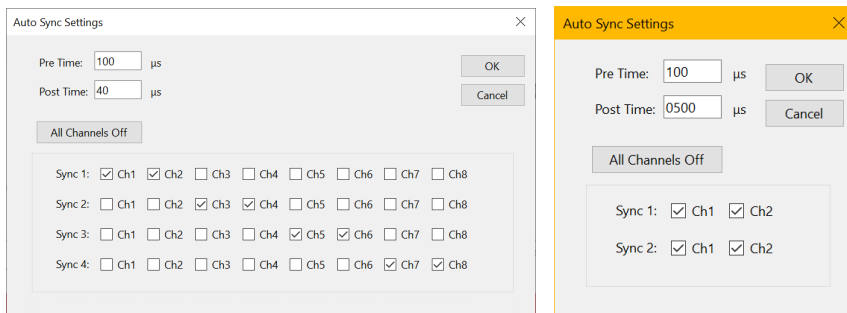

2. Assign the analog stimulus channels that will be used as the basis for autocreating the protocols on the Sync Out channels 1 to 8. For example, if you use only stimulus channel 1, select Ch1 under Sync1. If you use an amplifier, you can use up to two output channels per amplifier, that is, you may want to select Ch1 and Ch2 for Sync1. The preceding screen shot shows an advanced setup that could be used, for example, for a setup with 4 amplifiers, each connected with two analog STG channels and one Sync Out.

3. Set the time offset of the TTL's rising edge before the stimulus pulse „Pre Time“ and of the TTL's falling edge after the pulse „Post Time“. For operating an amplifier, a „Pre Time“ of 0 µs and a „Post Time“ of 100 µs are default, but especially the „Post Time“ may have to be adjusted according to your stimulus amplitude and the stimulus artifact suppression performance.

4. On the Settings menu, click Auto Sync to enable the Auto Sync feature. The Sync Out protocols will be autocreated in synchrony with the pulse protocols on the assigned channels, will show up in the WYSIWYG window immediately, and will be downloaded onto the STG with your next download. (Please make sure that the display and download options are appropriate, that is, all necessary Sync Out channels are selected.) The worksheets of the Sync Out channels assigned to the Auto Sync feature will be unavailable, that is, you cannot edit them manually. The following screen shot shows an example of a monophasic 100 µs voltage pulse on channel 1 and the corresponding Auto Sync pulse (Pre Time 100 µs, Post Time 40 µs) on Sync Out 1.

5. If you later choose to edit the „Sync Out“ worksheets of the active file manually, you can deselect the „Auto Sync“ feature on the „Settings“ menu. Any information in the „Sync Out“ worksheets that was there before the „Auto Sync“ option was enabled will be restored; and all worksheets will be available for manual editing.

Amplitude Control

Adjusting the Stimulus Intensity Level

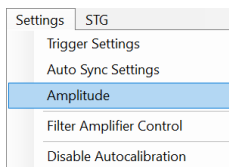

Click option “Amplitude” in the “Settings” menu. The “Amplitude Control” dialog opens.

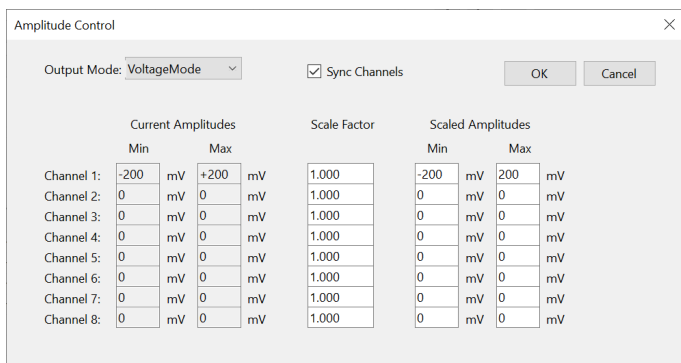

Click option „Amplitude“ in the “Settings” menu. The “Amplitude Control” dialog opens.

Adjust the “Output Mode” from the drop down menu in the header. Select the check box “Synch Channels” to include them.

See “Current Amplitude”, “Scale Factor” and “Scaled Amplitudes” in comparison.

After having programmed the stimulus protocol, you can either download the protocol "as is", or you can adjust the stimulus intensity level, that is, choose a „Scale Factor“ of the programmed amplitudes. You can adjust the level offline and download the information onto the stimulus generator manually afterward, or you can adjust the level on-the-fly, without stopping the running stimulation. This feature is especially convenient for testing out thresholds that evoke a biological response.

Note: The error messages that are displayed when the stimulus amplitude is not set to zero at the end of the protocol or when the time length of stimulus protocols is different on individual channels can present a nuisance when adjusting the level on-the-fly. These error messages can be switched off by deselecting the option Enable Compiler Warnings on the Settings menu.

The WYSIWYG display is updated automatically. The worksheet is not updated. It always relates to the stimulus protocol that you programmed initially. If “Auto Download” is selected, changes are immediately downloaded onto the stimulator after entering the level, and the stimulus protocol is restarted from the beginning, with the adjusted stimulus intensity level.

Filter Amplifier Control

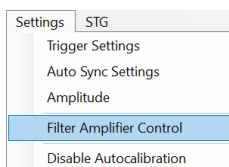

Change the “Filter Amplifier Gain” via radio box “x 100, x 200, x 500 or x 1000”.

Define whether to “Measure “ or to “Stimulate” each of the up to 8 channels individually.

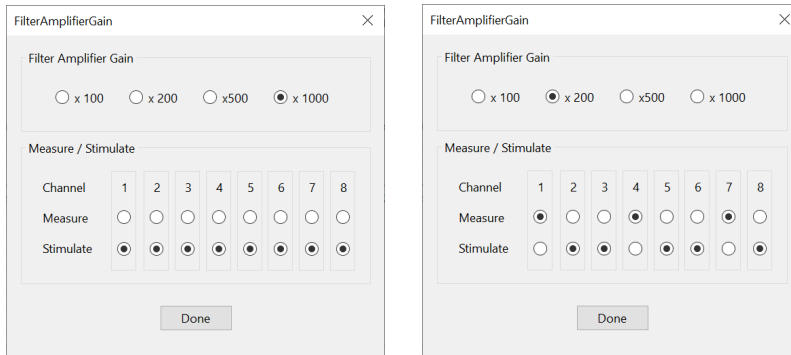

Autocalibration

Click option „Disable Autocalibration“ in the “Settings” menu.

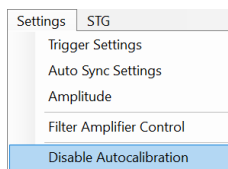

During the first ten minutes after starting the STG, the device emits every minute high frequency signals (small bursts) for internal offset calibration of the current outputs in a range of ± 10 mV. After warming up the STG, the calibration signals later will be delivered half-hourly.

Note: It is recommended to start the STG5 ten minutes before use to allow warming up!

Highly sensitive measuring equipments will monitor these calibration signals as artefacts which might disturb the stimulation when using very low stimulus pulses ($< 100 \mu\text{A}$) in current mode. Enable the option “Disable Autocalibration” in the “Settings” menu to avoid the autocalibration. The command is automatically downloaded to the STG5.

ASCII Import / Export

Click „File“ menu and select „Import / Export ASCII Files“.

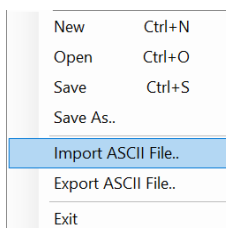

Import ASCII Files

The ASCII import filter is used to load stimulus protocols from an ASCII file into the stimulus worksheet of MC_Stimulus III.

You can use this feature for feeding recorded signals, for example, exported from Multi Channel Experimenter or MC_Rack, into the stimulus generator. You can also export the data from MC_Stimulus III, modify it with your custom text or spreadsheet editor, and reimport it into MC_Stimulus III.

Supported File Formats

The ASCII text must exactly follow the specifications below. The parameters in angle brackets are placeholders for any valid numbers or strings.

Hint: You can set up files conveniently in any standard spreadsheet program and save them as tab-delimited ASCII.

General

- The file name and the file name extension are not important. You can use any extension you like, for example *.txt, or *.dat, or any other.
- Comments are introduced by the number sign #. The rest of the line after # is only for your information; it is completely ignored when executing the stimulus file. (You do not need comments, of course, but it is convenient for documentation.)

Hint: Use # to comment lines out. That is, you can disable lines without removing it from the file. Thus, you can keep the lines for later uses.

- Blank lines are ignored.
- The spelling is strict. The MC_Stimulus III program does not recognize a keyword if it is misspelled or if even only one character is missing, but it is not case-sensitive.
- The file has the following structure: 1. File header, 2. Data

File Header

The first two non comment lines have to be the following lines. Files for older versions of the import filter (version 1.00) can be imported with the current version as well.

```
Multi Channel Systems MC_Stimulus III
ASCII import Version 1.10
```

The next three lines have to be the following lines (in any order).

```
channels: <number>
output mode: <mode>
format: <format number>
```

Make sure you define the total number of channels for the used STG properly (4 channels for a STG with 4 channels, 8 channels for a STG with 8 channels, and so on), according to the software version. You can select the maximum number of channels during the installation of MC_Stimulus. On the Help menu, click About MC_Stimulus III to check your current software version.

Example:

You have to include the following line in the ASCII file if you have installed MC_Stimulus III for STG2004.

channels: 4

Output mode is either voltage or current.

Example:

output mode: voltage

Six different format types are available: 1, 2, 3, 4, 5, 6.

Example: *format: 3*

Data

Preceding the data, the output channel number has to be specified by the following line.

```
channel: <channel number>
```

You can specify analog output channels from 1 to 8 (limited by the number of analog output channels of the connected STG, of course). The digital Sync Out channel number directly follows the maximum number of output channels. For example, if you have installed MC_Stimulus III for 4 channels, the Sync Out channel is channel number 5; if you have installed MC_Stimulus III for 8 channels, the Sync Out channel is channel number 9.

The data follows after the channel specification line; three format types are available. All format types follow the MC_Stimulus III worksheet's structure of rows and columns. See the description of the worksheet for more details. Columns are separated by blanks or tabs. The first line has to contain the column headers. The following lines contain the voltage/current and time values. Rows/lines are separated by a carriage return or line feed (CR / LF). This is the Windows standard control character inserted when you press the ENTER key.

The voltage unit is mV and the current unit is μA . Please make sure that all values are in the ranges specified for the STG you use. For the Sync Out channel, only values of 0 and 1 are allowed.

The time unit is μs . Time values can be in the range from 20 to 18.000.000.000 (20 μs to 5 h). Time base of the STG is 20 μs , so only times that are multiples of 20 μs are valid.

Note: Please make sure that there are no additional tabs or characters, which would lead to an error message. Show tabs and spaces in your text editor and check the file before importing it.

Format type 1

This is a basic format with two columns of „Value“ and „Time“ each, without „Repeat“ functionality.

Value	Time	Value	Time
-------	------	-------	------

Format type 2

With this format, you can repeat rows in the same way as described for the worksheet. Group repeat is not available.

Value	Time	Value	Time	Repeat
-------	------	-------	------	--------

Format type 3

This format type is available only in the current version of the import filter. It allows you to use a third column of „Value“ and „Time“.

Value	Time	Value	Time	Value	Time	Repeat
-------	------	-------	------	-------	------	--------

Format type 4

This format type is available only in the current version of the import filter. It is the plainest format with only one column for the voltage / current values and one column for the time lengths. This format is the standard format if you want to import data for example from Excel.

This format type is generated when exporting MC_Stimulus III files as ASCII.

Value	Time
-------	------

Format type 5

This format type is available only in the current version of the import filter. It allows you to use ramp and sine waveforms as well as rectangular waveforms. You specify the Pulse type in the first column, and the waveform in the three following columns. The general rules for setting up ramp and sine waveforms fully apply (see also Pulse Types). The pulse types are defined by the following numbers: Rectangular = 0, ramp = 1, sine = 2.

You can only use the rectangular type (0) for the Sync Out channels.

Important: When setting up rectangular or sine waveforms in this format type, you need only one value column for defining the amplitude, but you have to define both value columns even so. The first value column is ignored for rectangular and sine pulse types by the MC_Stimulus III program.

Pulse	Value	Value	Time
-------	-------	-------	------

Example:

This is an ASCII file viewed in a standard text editor program. You can see the tabs, spaces, and CR / LF.

For demonstration purposes, a ramp type pulse was programmed on the first channel, a sine wave on the second channel, a rectangular waveform on the third channel, and mixed pulse types on the fourth channel.

```

1 # file: example.dat
2 # Copyright (c) 2005 Multi-Channel Systems
3 # this is an example file for MC_Stimulus ASCII import
4
5 Multi-Channel-Systems-MC_Stimulus
6 ASCII import Version 1.10
7
8 # this is a comment line
9
10 channels: 8
11
12 output mode: voltage
13
14 format: 5
15
16 channel: 1
17
18 pulse» value» value» time»
19 2» 0» 8000» 800000
20 2» 0» 4000» 400000
21 2» 0» 2000» 200000
22 2» 0» 1000» 100000
23
24 channel: 2
25
26 pulse» value» value» time»
27 1» 0» 8000» 200000
28 1» -8000» 0» 200000
29
30 channel: 3
31
32 pulse» value» value» time»
33 0» 0» 3500» 200000
34 0» 0» -3000» 200000
35
36 channel: 4
37
38 pulse» value» value» time»
39 0» 0» 3500» 200000
40 1» 0» 8000» 200000
41 2» 0» 8000» 800000
42
43

```

After loading the file into the MC_Stimulus III worksheet, you can edit and download the file as usual.

Format type 6

Note: This file format is used by MC_Rack ASCII export!

This format type is available only in the current version of the import filter. This is a basic format with two columns: The absolute time in seconds, and the absolute value of voltage in microvolts (μV) or current in microampere (μA). This file format is used by MC_Rack and Multi Channel Experimenter ASCII export. You can directly import the software export files into MC_Stimulus III.

Time	Value
------	-------

You can use this format with or without header.

Example:

The following picture shows a file of format type 6 without header.

T	elec0001 29
[s]	[μV]
0.000040	8.541667
0.000080	2.187500
0.000120	12.708333
0.000160	8.854166
0.000200	7.083333
0.000240	5.729167
0.000280	15.104167
0.000320	13.854166
0.000360	12.500000
0.000400	1.875000

The following picture shows a file of format type 6 with header.

```
Multi Channel Systems MC_Stimulus
ASCII import Version 1.10

channels: 8

output mode:

format: 6

channel: 1

time          value
[ $s$ ]         [ $\mu V$ ]
0.000040     8.541667
0.000080     2.187500
0.000120     12.708333
0.000160     8.854166
0.000200     7.083333
0.000240     5.729167
0.000280     15.104167
0.000320     13.854166
0.000360     12.500000
0.000400     1.875000
```

Using the format type 6 without header, only the first channel of the MC_Rack raw data file can be imported. Using the format type 6 with header you choose how many channels are imported in "channels", line 3. The output mode in line 4 has to be voltage. You choose which channel should be imported first in "channels" line 6. You can add the channels you also want to import one after the other in any order.

The value microvolt is normally used for data recording in voltage mode of MC_Rack. The STG generates voltage pulses in values of millivolt. Please use the "Amplification" factor of the ASCII Import Dialog to convert μV in mV, otherwise the output of the STG is zero. The amplification factor is generally applied in files with and without header.

ASCII Import of Files

For ASCII import of files, please use the command ASCII Import in main menu "Settings". The dialog "ASCII Import Settings" will open.

Settings for ASCII import files without header:

Select the format type from one to six from the drop down menu "Format".

Select the number of the row from which the file should be imported. Row numbers are available from one to ten from the drop down menu "From row". Select the "Output Mode" in the check boxes: Voltage or Current.

Settings for ASCII import files with or without header:

Please choose the factor of amplification in "Amplification". This is very helpful, for example, for importing data recorded in microvolt μV and now needed in millivolt mV. That means, the factor is 1000 or – for higher stimulation signals – may be 10000. Please see chapter "Format Type 6" above.

Important: MC_Stimulus III uses the header of an ASCII import file, if a header is available. If no header is available, MC_Stimulus III applies the settings of the dialog "ASCII Import Setting".

SYNCHRONIZING EVENTS

Digital Output Signals (Sync Out)

The output of the digital Sync Out outputs is a 3.3 V TTL signal. A logic state of 1 means 3.3 V, and a logic state of 0 means 0 V. Please note that the digital output is about 15 μ s faster than the analog output. This small offset is generally sufficient to make sure that the Sync Out signal precedes the stimulation, which is important for synchronizing events.

You can program the output signal of the Sync Out channels in the same way as the analog output signals, but due to the nature of a digital signal, only values of 0 and 1 are allowed.

The output signal can be used for triggering external devices, for example, the data acquisition MEA2100-System. Please note that if you use it for triggering the MEA2100-System, you should use output signals that have a duration of at least 200 μ s; otherwise it can happen that the device ignores trigger events.

All Sync Out outputs are active when the STG is started by pressing the Start / Stop button, or by using the software command "Start" on the STG menu.

If you are using the "Trigger In" inputs for starting the STG, each of the Sync Out channels is controlled by a separate "Trigger In" channel. Sync Out 1 is active when Trigger In 1 is triggered, Sync Out 2 is active when Trigger In 2 is active, and so on. The assignment of Sync Out channels to "Trigger In" inputs can be customized, please see chapter "Trigger Settings".

If you use the "Repeat" feature in the "Trigger Settings" dialog, the corresponding Sync Out signal is repeated as well as the selected analog output signals.

You can, for example, synchronize four separate displays or other virtual instruments in Multi Channel Experimenter or MC_Rack software, one for each trigger input. You can also define a bit pattern in the "Trigger Detector" and trigger instruments on this bit pattern, for example to activate virtual instruments only when trigger 1 and 3 are active at the same time. Please see the respective software manual for more information on the "Trigger Detector" and triggering.

Note: No Sync Out signal is sent when the STG5 is stopped on a trigger event or by pressing the Start / Stop button, that is, if the trigger event occurs or the button is pressed when the STG5 has still been active.

Timing of blanking signal

If you have a MEA amplifier with blanking circuit in use, you can apply a blanking signal (TTL pulse) for transiently switching off the input stage of the amplifiers during the stimulus, thus avoiding the stimulus artifact. MCS recommends a minimum blanking pulse that starts with the stimulus and stops 100 μ s after the stimulus. The fact that the digital output of the stimulus generator from MCS is about 15 μ s faster than the analog output ensures that the blanking signal is delivered before the stimulus. It is very important that the blanking pulse is delivered shortly before the stimulus.

You can use the "Auto Sync" feature for autocreating the "Sync Out" pulses without entering values manually. Please see "Auto Sync for Autocreating Synchronous Sync Out Pulses".

Trigger Settings

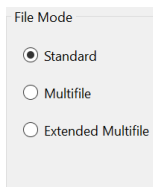

Triggering Output Channels (Standard Mode)

The trigger settings are saved in the currently active MC_Stimulus III (*.stm) file. Please assign the triggers to the analog output channels in the "Trigger Settings" dialog box in the "Settings" menu.

In the following example, trigger input 1 is used to trigger the output channels 1, 3, and 6. This means, each time a TTL pulse is applied to "Trigger In" 1, stimulation on channels 1, 3, and 6 is started simultaneously. The complete protocols of these three channels would be executed three times after the trigger event, if continuous mode would be off. However, as continuous mode is activated, trigger repeats are disabled and the protocols will be repeated indefinitely, until a manual stop occurs.

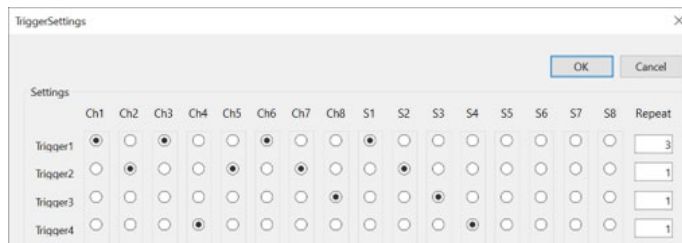

Important: Only channels assigned to the same trigger have the same time base. Between channels assigned to different triggers, time shifts in the order of the STGs time resolution (20 μ s) may occur.

The Sync Out outputs are assigned to their default trigger inputs, that is, Sync Out 1 is active when trigger 1 is active, and so on. You can change this assignment with the option buttons, for example, assign multiple Sync Outs to the same trigger.

The Sweep status light (LED Start / Stop buttons) indicates the trigger numbers that have been assigned to active channels.

Example: If channels 1 and 3 are assigned to trigger 1, and trigger 1 is started, either by the software controls, the *Start* button on the stimulus generator's front panel, or the trigger input 1, the first *Sweep* status lamp indicates the active state of channel 1 or 3, even if one of the two channels has a shorter output sweep than the other and is not active anymore.

Triggered action when channel(s) still active

You can define what action should be taken when any of the channels assigned to the trigger are still active.

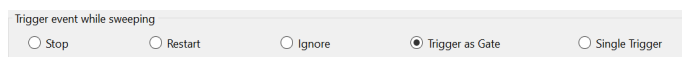

Stop: A following trigger input stops the stimulation on the assigned channels if at least one channel that has been assigned to this particular trigger is still active in the moment of the trigger event. The trigger event starts stimulation only if no channel that has been assigned to this trigger is active.

Restart: The stimulus protocols on all channels assigned to this trigger are started at the trigger event, regardless of the activity on these channels.

Ignore: The trigger event is ignored when any channel assigned to this trigger is active. The trigger event starts stimulation only if no channel that has been assigned to this trigger is active.

Use Trigger as Gate

Channels associated with a trigger input will be active as long as the condition of that trigger is 1 (HIGH) and switched off as soon as the condition becomes 0 (LOW). If the stimulation protocol is shorter than the gate, it will stop at the predefined time, regardless of the gating trigger. If the stimulation protocol is longer than the gating trigger, stimulation will stop when the gating trigger ends.

For example, if you want to produce a repeated rectangular pulses that last as long as the gating trigger is HIGH, you can do the following: program a single rectangular pulse and activate the continuous mode. The pulses will start as soon as the gating trigger becomes HIGH and stop as soon as the gating trigger becomes LOW. If the voltage of the stimulation channel is different from 0 at the time the gating trigger ends, the channel will be switched off immediately. If you stop the stimulating protocol manually during the gating trigger in HIGH, stimulation is stopped but immediately restarted, and goes on until the gating trigger ends.

Warning: Once selected, this setting will become the default setting for all opened files, until unselected. So, if you observe unexpected behaviour when triggering the STG5, check the trigger settings.

Single Trigger

Additional to the general trigger states “running” and “stopped” each trigger can now be set up in a new state, called “armed”. That means, the trigger is ready to start the stimulus protocol, but waiting for an external signal from the rear panel trigger inputs to execute the stimulus protocol one time only. In “armed” state, the “Sweep” LED on the front panel of the STG will light up, but the brightness of the LED is not as brilliant as in “running” state.

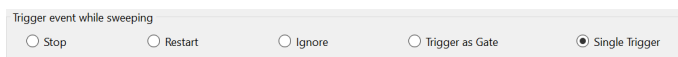

Select “Single Trigger” if you want to start the stimulus protocol once via external trigger.

Set up your stimuli with the MC_Stimulus III program. Download the stimulus protocol from a MC_Stimulus III file to the STG5. 

Arm the STG5 either manually by pressing the “Start / Stop” button on the front panel, or with software controls. To arm the STG5 via software, use the start icon in MC_Stimulus III main menu, or click the combined LED / Start / Stop button for the “Sweeps”. When armed, the STG5 accepts one single trigger on its trigger input. The trigger input must be connected to the device which generates the trigger.

To start the stimulus protocol a second time, the STG5 needs to be armed again manually. As long as the STG is armed, the LED in MC_Stimulus III appears blue to indicate the armed state.

The stimulation will automatically be started after applying the single trigger from the external device. The LED in will turn to red while the trigger is running and return to grey after the trigger has finished the stimulus protocol. The STG needs to be armed again to accept the next trigger.

It is possible to stop the stimulation at any time while the STG is armed or is running via Start / Stop button on the front panel of the STG5 device or via software.

Triggering Stimulation (Trigger In)

The external trigger input has to be a TTL signal of at least 40 μ s length. TTL pulses shorter than that may not be recognized by the stimulus generator.

A TTL pulse is defined as a digital signal for communication between two devices. A voltage between 0 V and 0.8 V is considered as a logical state of 0 (LOW), and a voltage between 2 V and 3.3 V means 1 (HIGH). It is the same kind of signal as the output signal of the “Sync Out” output of the STG5.

The rising edge of the “HIGH” trigger input starts and stops the STG5. The time lag between the rising edge of the TTL input and the stimulus output is $70 \pm 10 \mu$ s. The minimum distance between two trigger inputs is 100 μ s, resulting in a maximum trigger frequency of 10 kHz. If a higher frequency is used, the stimulus generator is likely to miss trigger inputs. See the illustration below for more details on the timing. Please note that the digital “Sync Out” output is about 15 μ s faster than the analog outputs. See Digital Output Signal (Sync Out) for more information.

You can either trigger separate output channels (Standard mode) or separate MC_Stimulus III files (Multifile mode). There is also one separate “Sync Out” output for each trigger input. You can assign the “Sync Outs” to the trigger inputs in the “Trigger Settings” dialog. The default settings are that Sync Out 1 is active when Trigger In 1 is triggered, Sync Out 2 is active when Trigger In 2 is active, and so on. See also “Digital Output Signals” for more information on the Sync Out channels.



The Sweep status display (LED Start / Stop buttons) in the main window of the program shows active sweeps that were started by the triggers. That means, the status lamp that corresponds to trigger 1 lights red as long as any channel triggered by trigger 1 is active. Please note that the number of the analog output channel is irrelevant, the “Sweep” status lamp refers only to the trigger number.

Example: Assume that channel 4 is assigned to trigger 1. When channel 4 is active, the first Sweep lamp lights red, because the first Sweep lamp refers to trigger 1.

You can start and stop the trigger manually at any time using the LED Start / Stop buttons.

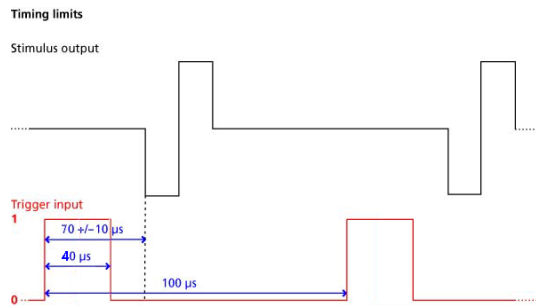

Custom switch for "Remote Controlling" of the STG5

You can connect any device that produces TTL outputs to the "Trigger In" connector of the STG5, for example a switch. For example, you can use a trigger for remote controlling the STG5 if it is not within reach during an experiment. It is also possible to set up advanced experiments where stimulation depends on preceding activities of the studied object.

The following picture shows a suggested circuit diagram for a switch used for remote controlling. The resistor and capacitor work as a low-pass filter on the TTL signal and are necessary to reduce ringing of the signal.

Suggested switch for triggering the STG

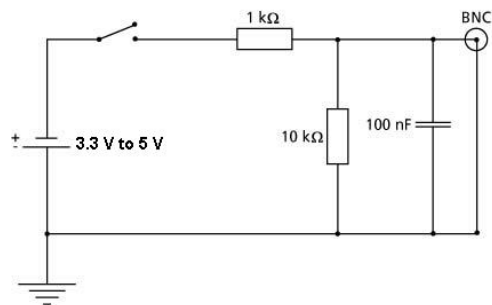

Multifile Mode

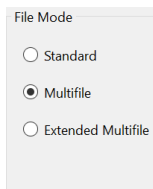

As an alternative to triggering separate channels in a single stimulus protocol, you can also trigger up to four separate stimulus files in the “Multifile” mode. This feature allows you to trigger different stimulus protocols on overlapping channels. For example, you can control stimulus pattern A by trigger 1 on channels 1 and 2, and stimulus pattern B by trigger 2 on channels 2 and 3, and so on.

The “Multifile” mode is indicated in the MC_Stimulus III “File Mode” window in the main window. If you use the “Multifile” mode, you cannot use the trigger inputs anymore for triggering single channels. When you start the download, all selected up to four stimulus files are downloaded onto the stimulus generator. When Trigger In 1 is active, the file assigned to Trigger 1 is started together with all downloaded output channels; when Trigger In 2 is active, the file assigned to Trigger 2 is started, and so on. You can choose what action should be taken when a trigger event occurs during the time when the assigned file is still playing.

If the STG5 is started by the START / STOP button on the front panel or the “Start” command of MC_Stimulus III, only the first / top selected file in the Trigger Settings dialog box is started. This is usually the file assigned to trigger 1. For downloading and starting multiple files without triggering, please use the “Batch Mode”.

Important: As long as you are in the “Multifile” mode, the “Standard” trigger settings (trigger inputs assigned to single channels) will have no effect. You also cannot close files if you are in “Multifile” mode.

Please read also chapter "Extended Multifile Mode".

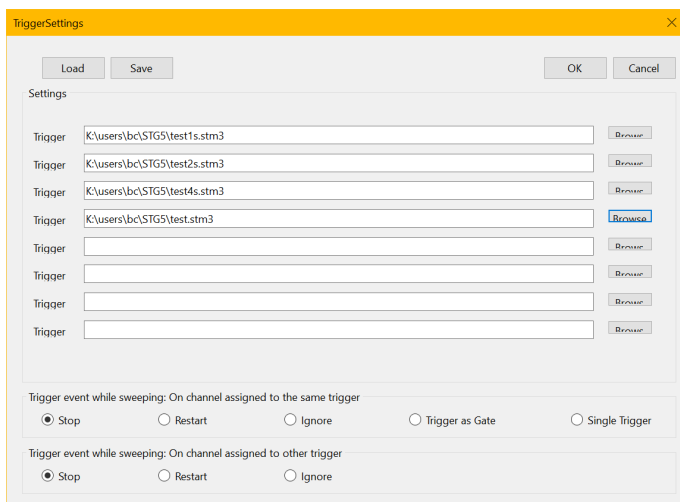

1. Select the option Multifile in the “File” window of the main menu.
2. On the “Settings” menu, click “Trigger Settings”.
3. Connect all necessary trigger inputs to TTL signal sources.
4. Set up your stimulus protocols and save the files.
5. Under Trigger 1, click “Browse” and select the appropriate stimulus protocol that you want to assign to trigger 1.
6. Repeat step 5 for all necessary trigger inputs. Confirm the settings by clicking “OK” button.
7. All selected files are opened automatically.
8. Check all stimulus protocols before download. Please make sure that you have selected all necessary channels under “Download Channel” for each file separately.
9. Download the files onto the STG5 by clicking “Download” button on the STG5 menu.
10. The stimulation as specified in the selected MC_Stimulus files will now be triggered by the selected trigger inputs.



Triggered action when channel(s) still active

You can define what action should be taken when any of the channels assigned to the trigger are still active. In addition, you can also define what action should be taken when any of the channels not assigned to the trigger event are still active. Please click the expand button to show the advanced options:

- **Stop:** A following trigger input stops the stimulation on the assigned channels if at least one channel that has been assigned to this particular trigger is still active in the moment of the trigger event. The trigger event starts stimulation only if no channel that has been assigned to this trigger is active.
- **Restart:** The stimulus protocols on all channels assigned to this trigger are started at the trigger event, regardless of the activity on these channels.
- **Ignore:** The trigger event is ignored when any channel assigned to this trigger is active. The trigger event starts stimulation only if no channel that has been assigned to this trigger is active.

Example:

File A is assigned to trigger 1 and file B to trigger 2. Consider the following two situations:

- Trigger 1 is activated, but channel 3 in file A is still active. As channel 3 from file A is assigned to trigger 1, the settings defined for "on channel assigned to same trigger" would be applicable.
- Trigger 1 is active, but channel 3 in file B is still active. As channel 3 from file B is assigned to trigger 2, the settings defined for "on channel assigned to other trigger" would be applicable.

Extended Multifile Mode

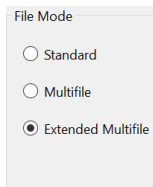

The "Extended Multifile" mode is a very flexible mode for advanced users. It can be used with stimulus generators of the 4000 and STG5 series with a digital IN / OUT connector only that means, STG 4004, STG 4008. It is possible to download up to nine different stimulus patterns in the default setting of the "Extended Multifile Mode". Selecting the option "Show all Patterns" the program supports 256 different patterns of stimulation. You can download up to 256 stimulus patterns in advance and select among them. You can use one of these stimulus patterns at a time of your choice with a digital signal. Please read also chapter "Multifile Mode".

This high number of different stimulus patterns are selected via the digital IN / OUT connector. Please see the pin layout of the 25-pin D-Sub connector in the appendix. Pin 1 to pin 8 of the connector refer to digital input D0 to D7. Pin 9 to pin 16 refer to digital output D8 to D15, but they are not connected. Pin 17 to pin 25 are grounded. If you do not use all eight digital inputs, you have to connect them to ground manually, otherwise they count like 1 = high. It is recommended to build a connector.

Important: All channels are assigned to trigger 1. Please make sure that you do not use any other trigger input.

Each time when trigger 1 is activated, the program applies that one of the stimulus pattern which currently is selected by D7 to D0.

Assignment of the digital inputs D7 to D0

Decimal	Binary Pattern							
	D7	D6	D5	D4	D3	D2	D1	D0
0	0	0	0	0	0	0	0	0
1	0	0	0	0	0	0	0	1
2	0	0	0	0	0	0	1	0
4	0	0	0	0	0	1	0	0
8	0	0	0	0	1	0	0	0
16	0	0	0	1	0	0	0	0
32	0	0	1	0	0	0	0	0
64	0	1	0	0	0	0	0	0
128	1	0	0	0	0	0	0	0

Settings		
	Pattern	Filename
0	00000000	K:\users\bc\STG5\test1s.stm3
1	00000001	K:\users\bc\STG5\test2s.stm3
2	00000010	K:\users\bc\STG5\test4s.stm3
4	00000100	K:\users\bc\STG5\test.stm3
8	00001000	
16	00010000	
32	00100000	
64	01000000	
128	10000000	

The user is asked to compose his own stimulation pattern files. Please do not create too big stimulus files, because all files are completely downloaded, and stored in the memory of the STG5. If the files contain too much data, and you apply a lot of files, you will get an error message on download. The advantage of this mode is to have all stimulus files directly in the memory of the STG5, and thus there is no time lag when starting a new stimulus pattern on each trigger.

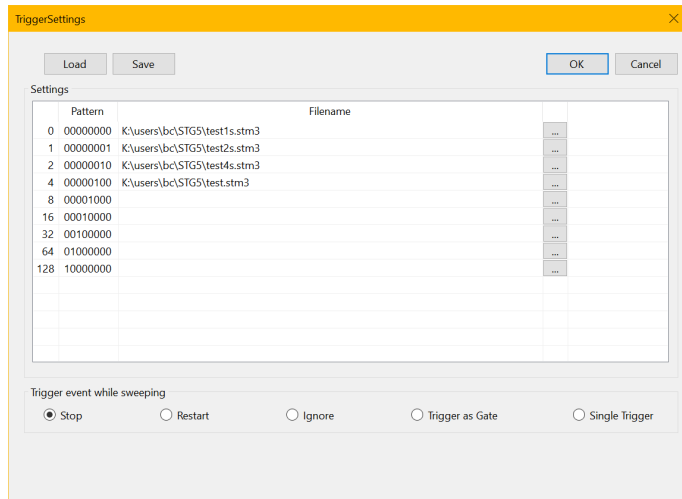

To arrange the created stimulation files, you have to click on the grey square on the right side of each row. A dialog will open, and you can choose the file you want to place in this position. The complete arrangement of the files can be saved as "Extended Multifile" configuration file with the command "Save", and load again with "Load". The configuration file for the "Extended Multifile Mode" has the extension "*.mf2".

You can edit each file, created in "Extended Multifile Mode" with the extension "*.mf2" with a common editor.

Please make sure to use the correct format.

1. Connect the digital IN /OUT connector to a TTL signal source.
2. Ground digital inputs manually which are not used.
3. Set up your own stimulus protocols, either nine stimulus patterns or up to 256 patterns, and save the files.
4. Select the option "Extended Multifile" in the "File Mode" window of the main menu.
5. On the "Settings" menu, click "Trigger Settings".
6. Define the desired files to each of the positions, or load a configuration file (*.mf2) for the "Extended Multifile" mode.
8. Close the dialog by clicking "OK".
9. All selected files are opened automatically.
10. Check all stimulus protocols before download.



11. Download the files onto the STG by clicking "Download" button on the STG5 main menu.
12. The stimulation as specified in the selected MC_Stimulus III files will now be triggered by trigger input 1.

Batch Mode

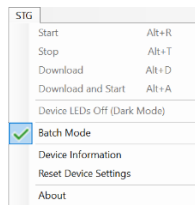

You can download and run several stimulus files one after the other in the Batch mode. The first file in the list is downloaded and started directly after the download, or started manually with the software or hardware controls, or started on a trigger. After the first file has been run, the next file in the list is downloaded, and so on, until the last file in the batch list has been run.

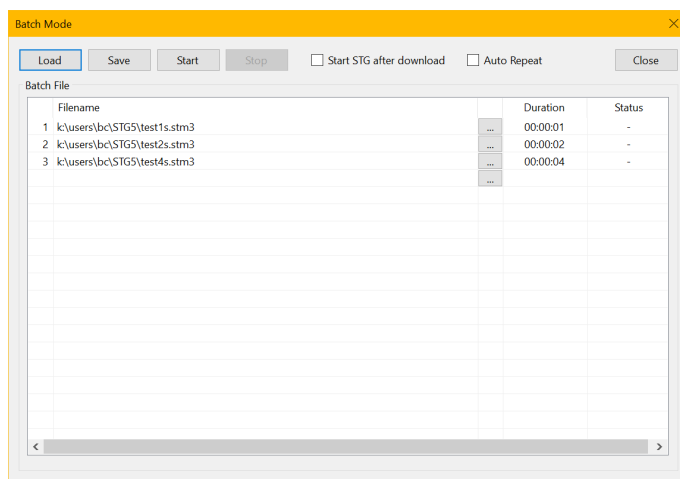

To add new files to the batch, please click "Load" for the "Open" dialog. Select the file(s) you want to add to the list. Save the complete list of batch files with "Save". The extension of the batch file is "*.stm3".

Triggering a sequence of stimulation protocols

The "Batch" mode is useful if you want to start a sequence of different stimulation protocols one after the other on the same trigger, please use "Trigger 1" only. Make sure that you have assigned all channels to "Trigger 1" in the "Trigger Settings" dialog box. You set up the protocols and save them as separate stimulus files. Then, you set up a batch file with a list of the desired stimulus files.

- The first trigger event starts the first file in the list.
- When a file has been completed, the next file in the list is downloaded automatically.
- When a trigger event occurs after the file has been run, the next file is started, and so on.
- When a trigger event occurs during the run of a file, the run is stopped, and the next file in the list is downloaded. The next trigger event starts the next file.
- Deselect the option Start STG after Batch Download on the Settings menu if you want to start the protocols on a trigger or manually with the software or hardware controls. If the option Start STG after Batch Download on the Settings menu is selected, the STG starts each file directly after the download without waiting for a trigger event.

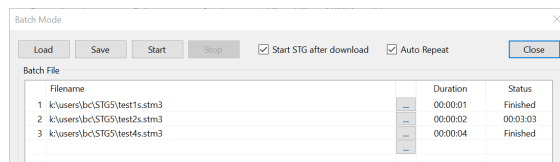

As an alternative to the "Batch" mode, you can also use separate trigger inputs to trigger separate output channels or separate stimulus files. This way, you can trigger up to four different pulse protocols (on separate channels). See the next chapter "Triggering Stimulation" for more details.

Note: Only "Trigger 1" is available for triggering in "Batch" mode. Do not use any other trigger inputs.

Splitting up stimulation protocols to circumvent the memory limitation

If the option Start STG after Batch Download on the Settings menu is selected, the STG starts each file directly after the download, which is only useful in the unlikely case that you need to circumvent the memory limitation of the STG. Split up your pulse protocol into several stimulus files and run them in Batch mode.

Operating the STG in Batch Mode

Important: You can operate the STG in Batch mode only with a valid computer connection. A file in the batch list is only downloaded after the preceding file has been run.

1. On the “Batch Mode” dialog, click “Load” to open a batch file. To add another batch file, please click the box .

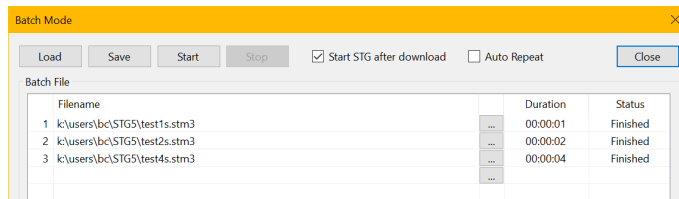

The “Open” dialog box appears.

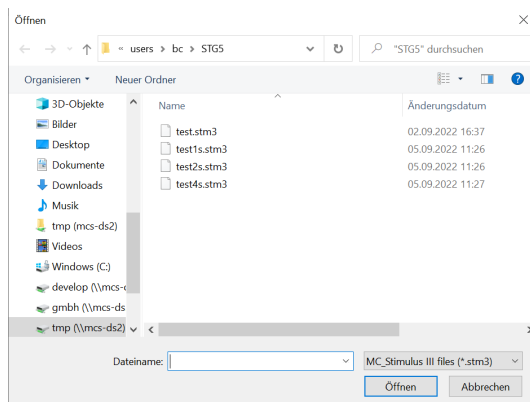

2. Browse your folders and select a valid batch file.
3. In the “Batch Status Display” all stimulus files in the batch are listed. Find their “Duration” and the “Status” of stimulation. “Save” the list of batch files for reusing them.
4. Click “Start” to start the download of the first file in the batch list (and the STG if the option “Start STG after download” in the header is selected). The progress of the pulse protocol is displayed in the “Status” column.
5. Click “Stop” in the “Batch Mode” dialog to stop the batch if necessary.
6. Close the “Batch Status Display” with the “Close” command.

Warning: The STG starts immediately after the download if the option “Start STG after Batch Download” has been selected. Make sure to deselect this option if you do not want to start the stimulation right away.

Autorepeat Option

If you select the “Autorepeat” in the header of the “Batch Mode” dialog. The batch is restarted with the first file after the last file in the batch has been finished.

ANALOG OUTPUT MODES

Output Modes

The stimulus generator STG5 operates in voltage and current mode. Choose voltage or current mode in the main window of MC_Stimulus III software. Please make sure that you use the appropriate stimulation mode for your experiment. The difference between current and voltage controlled stimulation is described in the following.

In voltage mode, the voltage level is held constant, and the current output depends on the electrode resistance: the higher the electrode resistance, the lower is the output current.

In current mode, the stimulus generator guarantees a stable current output independent of the electrode resistance, where the voltage is defined by Ohm's law. The higher the electrode resistance, the higher is the output voltage. Therefore, the kinetic properties of the stimulus output is affected by the load resistance, which is usually the electrode resistance. If the resistance is too high, the output current is limited by the compliance voltage, that is, too high resistances will result in a clipping of the output signal.

Please consider the time and voltage / current resolution of the stimulus generator STG5. The minimum pulse has an amplitude of 1 mV in voltage mode or 200 nA in current mode, supported by MC_Stimulus III; the firmware / DLL supports a 16 bit resolution, which means 100 nA for an output current range of 1.6 mA, and a time length of 5 μ s. Please note that if you work near these limits, that is, if you use very small amplitudes or very short pulses, the output waveform may not exactly match the programmed waveform.

Resolution Limits

Stimulus Output:

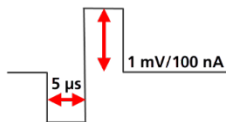

Ground

All stimulation channels of the STG5 are galvanically isolated from each other. Each channel has an independent ground (GND), which is usually connected to the ground of the experimental setup, for example, the amplifier, so that all devices refer to the same ground. Please make sure that you always use the appropriate ground for the channel in use.

Voltage Mode for STG400x series only

- If you want to operate the STG400x in voltage mode, you have to select "Voltage" in Output Mode of the main window of MC_Stimulus III. You will usually use the + and GND outputs. The output signal is identical with the programmed signal in the normal ranges of the electronics' accuracy. See illustration "Voltage mode: Standard Setup".
- The output signals are inverted (multiplied by -1) if you use the - outputs.
- If you use the voltage between + and -, the output signal amplitude is doubled. The - represents the ground (replaces GND) in this case. See illustration "Voltage mode: Doubled output signal amplitude".
- A bipolar stimulation is recommended for extracellular recordings from microelectrode arrays (MEAs) if a very high output signal density in a defined area between two neighboring stimulating electrodes is needed. The current that is delivered by the first electrode flows directly back to the second electrode so that the surrounding tissue is not affected. See illustration "Voltage mode: Bipolar stimulation".
- In the following example, you see a signal in the MC_Stimulus III display and the resulting output signals for the different connection options (viewed in a MC_Rack Data Display).

Programmed stimulus protocol viewed in MC_Stimulus III



Measuring Output Signals with an Oscilloscope

For test purposes, you can measure the output signals with an oscilloscope. Please see the appendix for the pin layout of the sockets on the front panel of the STG5 base.

STG5

What you do for measuring the voltage output is the following: Choose voltage mode in the main menu of the MC_Stimulus III software. You connect the output of the STG5 with a BNC cable to the oscilloscope.

Please note that you need a resistor in parallel to measure the current output properly because oscilloscopes measure voltages. If the input resistance of the oscilloscope is too low, the voltage output of the STG will be small as well, and you will not see any signals on the oscilloscope. MCS recommends a resistor of 10 k Ω .

Choose current mode in the main menu of the MC_Stimulus III software. You can now measure the potential difference over the resistor. You can then calculate the current output according to Ohm's law ($U = R \cdot I$). For example, if you stimulate with 100 μ A, the voltage over the 10 k Ω resistor has to be $U = 10000 \Omega \cdot 0.1 \text{ mA} = 1000 \text{ mV} = 1 \text{ V}$.

STG4000 Series

Most standard oscilloscopes have a probe with a ground cable. This probe is usually connected to the oscilloscope via a BNC socket. What you do for measuring the voltage output is the following: Choose voltage mode in the main menu of the MC_Stimulus III software. You plug in the standard STG cables into the +U output and the corresponding GND output. You then touch the open end of the cable from the +U output with the probe from the oscilloscope, and the open end of the cable from the GND output with the ground cable from the probe. This means you measure the potential difference between the +U output and ground.

Please note that you need a resistor in parallel to measure the current output properly because oscilloscopes measure voltages. If the input resistance of the oscilloscope is too low, the voltage output of the STG will be small as well, and you will not see any signals on the oscilloscope. MCS recommends a resistor of 10 k Ω because the output signal of the current output should then be identical to the output signal of the voltage output. You can use the same test protocol (regardless of the output mode) for the current and voltage outputs and compare the signals. As an alternative, you can also use a resistor that mimics the electrode resistance for testing your experiments.

Choose current mode in the main menu of the MC_Stimulus III software. What you do is, you plug in cables into the +I output and into the GND output of the STG. You then use alligator crimps for connecting a 10 k Ω resistor between the two open ends of the cables. You then touch the cable on one side of the resistor with the probe and on the other side with the ground of the probe. (Alternatively use the provided cable with integrated 10 k Ω resistor). That is, you measure the potential difference over the resistor. You can then calculate the current output according to Ohm's law ($U = R \cdot I$). For example, if you stimulate with 100 μ A, the voltage over the 10 k Ω resistor has to be $U = 10000 \Omega \cdot 0.1 \text{ mA} = 1000 \text{ mV} = 1 \text{ V}$.

The following illustration shows four possible combinations of connecting the current outputs on the front panel of the stimulus generator to the oscilloscope. Again, it is important that unused current outputs are connected to ground.

Capacitive Behavior of Stimulation Electrodes

Regarding the generally used stimulus pulses, stimulating electrodes behave as plate capacitors. They need some time to discharge themselves after stimulation. As a result, artifacts interfere with the recording, and electrodes deteriorate over time due to electrolysis. This effect takes place especially in current mode because the current cannot flow back to the stimulus generator due to the high output resistance in current mode and thus is kept in the electrode. A current source can constantly produce small currents, even though the current is set to zero. This might damage the connected electrodes over time. To avoid this problem, the STG400x is equipped with switches that automatically disconnect the current outputs from the current source 1 s after each programmed current stimulus. For the next stimulus, the current source is automatically reconnected. Due to the low offset currents of the STG5, there is no need for disconnecting the current outputs.

To reduce the effect described above in current mode, you should use biphasic pulses for stimulation. The stimulus signal should be immediately followed by an inverse signal of the same area (product of current and time), which helps to discharge the electrode. The easiest way is to use the same signal amplitude with an opposite polarity.

Multi Channel Systems recommends using voltage driven stimulation. In voltage mode, it is not necessary to use biphasic stimulation for discharging the electrodes, because the electrode should be discharged at a voltage of 0, that is, it would be sufficient to apply the negative phase only.

Warning: When using MEA electrodes of TiN material, stimulation with higher amplitudes is possible if you apply the negative pulse first. Also, regard the safe charge-injection limit as described in the MEA manual. Otherwise, electrodes can be damaged during stimulation.

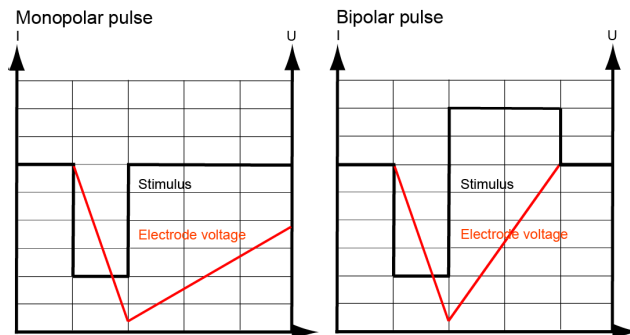

TECHNICAL SPECIFICATION

TECHNICAL SPECIFICATIONS: STG5

Operating temperature	10 °C to 24 °C
Storage temperature	0 °C to 50 °C
Operation humidity	10 % to 85 %, non-condensing
Storage humidity	10 % to 85 %, non-condensing
Dimensions (W x D x H)	Base: 325 mm x 310 mm x 27 mm Satellite: 325 mm x 310 mm x 37 mm
Weight	Base: 2.1 kg Satellite: 1.44 kg
Number of analog output channels	Base: 2 output channels Satellite: 2 per satellite, up to 3 satellites, that means up to 8 output channels
Output voltage	-8 V to +8 V @ max. \pm 20 mA
Output voltage resolution	250 μ V
Output current ranges	160 μ A, 1.6 mA and 16 mA
Output current resolution 160 μ A	6.25 nA
Output current resolution 1.6 mA	62.5 nA
Output current resolution 16 mA	625 nA
Rise time (10-90 %) voltage	1.7 μ s @ $\Delta U = 8$ V
Time lag between Sync Out and voltage output	2.5 μ s
Inherent rise time (10-90 %) current	2 μ s @ $R_L = 100 \Omega$, 16 mA
Time lag between Sync Out and current output	2.5 μ s
Resolution	16 bit
Time resolution	5 μ s
Output signals	Freely programmable (rectangular, ramp, sinusoidal)
Maximum frequency (rectangular waveform)	100 kHz
Memory capacity for stored waveforms	64 MB
Timing on external trigger	
Minimum time length of trigger input (TTL)	40 μ s
Time lag between trigger input and Sync Out	70 (\pm 10) μ s
Maximum trigger input frequency	10 kHz
Interface and connectors	
Coax connector for analog stimulation channels	2 per base, 2 per satellite
Coax connector for Sync Out for synchronization with following devices	2 per base, 2 per satellite
Coax connector for Trigger In for synchronization with preceding devices	8, only on the base device
Interface (connection to computer)	USB-C port
Download rate	max. 480 Mb per second
External power supply	
Supply voltage	100 – 240 VAC, 1.4 A, 50 - 60 Hz
Unit voltage	24 VDC, 60 W
Software	
MC_Stimulus III	Version 1.0 and higher
Operating system	Microsoft Windows [®] 10, (32 or 64 Bit), English and German versions supported
Data import / export	ASCII file format

Examples of Measuring Current Output Signals with an Oscilloscope

Graphic 1 160 μ A_1 ms_100 k.BMP

Current range 160 μ A: The graphic shows a biphasic pulse at 100 kOhm and IPI of 1 ms each.

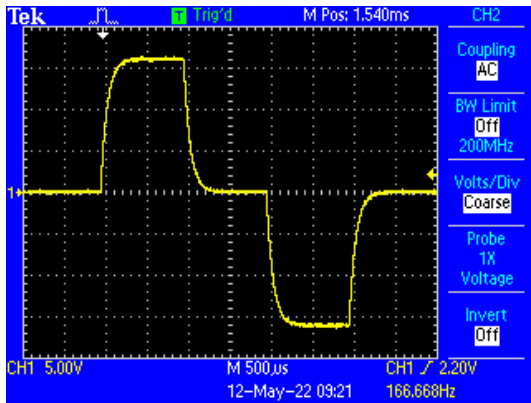

Graphic 2 1.6 mA_1 ms_10 k.BMP

Current range 1.6 mA: The graphic shows a biphasic pulse at 10 kOhm and IPI of 1 ms each.

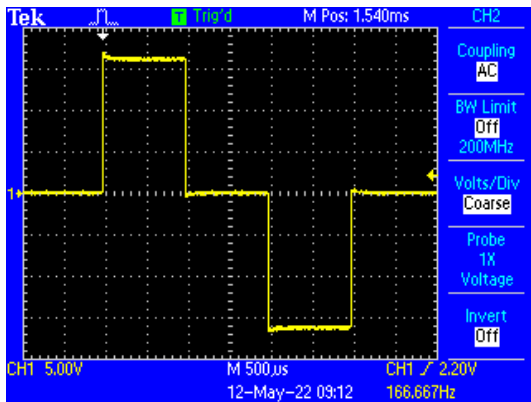

Graphic 3 16 mA_1 ms_1 k.BMP

Current range 16 mA: The graphic shows a biphasic pulse at 1 kOhm and IPI of 1 ms each.

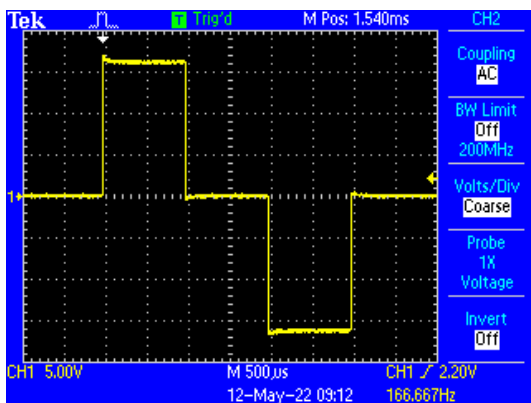

Explanatory Note to Graphic 1 to 3

The rising time gets longer when the current is smaller because the capacitance is loaded with less current, this lasts longer.

Graphic 4 2 μ A_10 MOszi_10 ms

Current range 160 μ A: The graphic shows a 2 μ A biphasic pulse at 10 MOhm and IPI of 10 ms each. The offset current is quite not measurable at 10 MOhm.

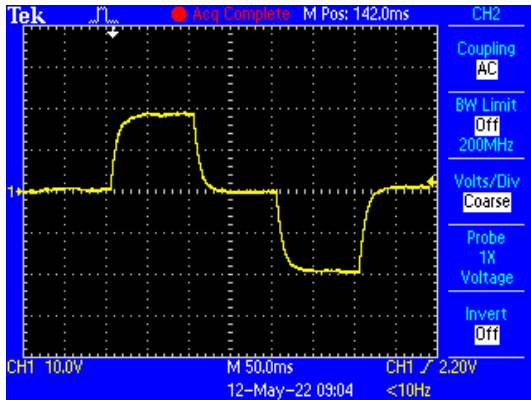

Graphic 5 1.6 mA + SYNC.BMP

The graphic shows a 1.6 mA pulse and the sync output. The latency between sync out and pulse is just 5 μ s.

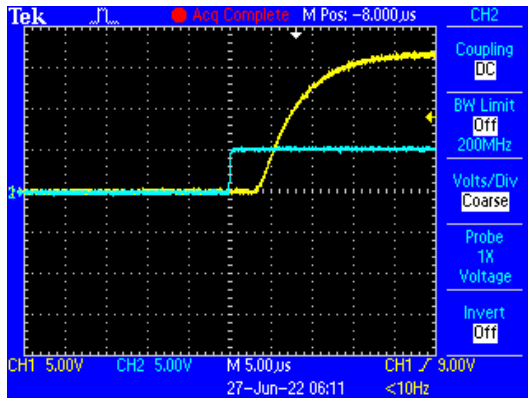

Graphic 6 5 V_1 ms_k.BMP

Voltage range: The graphic shows a 5 V biphasic pulse and IPI of 1 ms each.

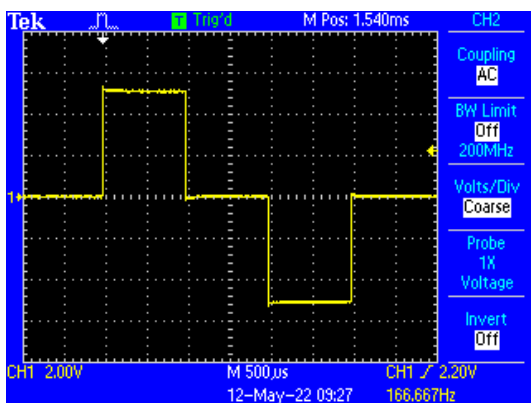

General Specifications

Time resolution	5 μ s		
Current range	160 μ A, 1.6 mA, 16 mA		
		Hardware	Software
Resolution	160 μ A	6.25 nA	100 nA
	1.6 mA	62.5 nA	1 μ A
	16 mA	625 nA	10 μ A

CONTACT INFORMATION

MAINTENANCE

Cleaning of the System

Always unplug the STG5 Base and Satellite devices prior to cleaning. To clean the exterior surfaces, use a lint-free cloth to remove loose dust. For more efficient cleaning, use a soft cloth dampened (not soaked) with an aqueous solution of 75 % isopropyl alcohol, or a mild detergent.

CONTACT INFORMATION

Local retailer

Please see the list of official MCS distributors on the [MCS web site](#).

Mailing list

If you have subscribed to the [Newsletter](#), you will be automatically informed about new software releases, upcoming events, and other news on the product line. You can subscribe to the list on the contact form of the MCS web site.

multichannelsystems.com