

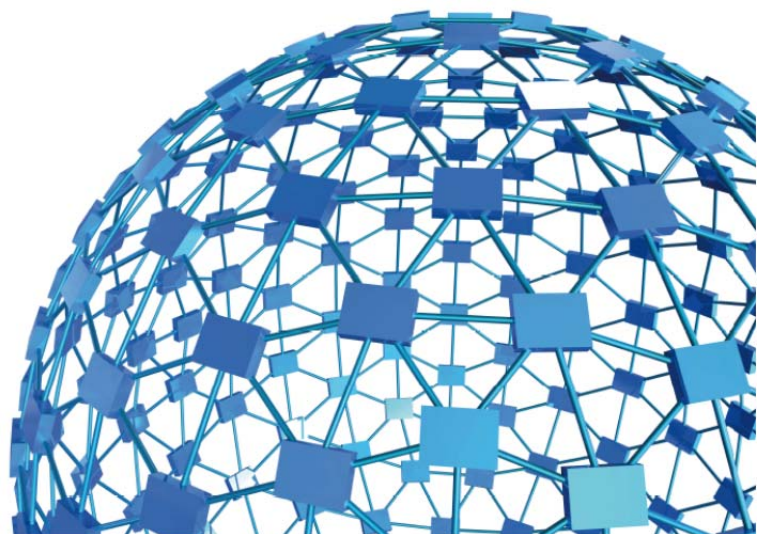

instruction manual

eVF Electronic Von Frey
Cat. No. 38450



UGO BASILE S.R.L.

sales@ugobasile.com / service@ugobasile.com www.ugobasile.com

UGO BASILE S.R.L.

Via Di Vittorio, 2
21036 GEMONIO, VA, ITALY
Phone: +39 0332 744574

sales@ugobasile.com / service@ugobasile.com
www.ugobasile.com

instruction manual

**eVF Electronic Von Frey
Cat. No. 38450**

Serial No.

SAFETY CONSIDERATIONS

ALTHOUGH THIS INSTRUMENT HAS BEEN DESIGNED WITH INTERNATIONAL SAFETY STANDARD, THIS MANUAL CONTAINS INFORMATION, CAUTIONS AND WARNINGS WHICH MUST BE FOLLOWED TO ENSURE SAFE OPERATION AND TO RETAIN THE INSTRUMENT IN SAFE CONDITIONS.

SERVICE AND ADJUSTMENTS SHOULD BE CARRIED OUT BY QUALIFIED PERSONNEL, AUTHORIZED BY UGO BASILE ORGANIZATION.

ANY ADJUSTMENT, MAINTENANCE AND REPAIR OF THE OPENED INSTRUMENT UNDER VOLTAGE SHOULD BE AVOIDED AS MUCH AS POSSIBLE AND, WHEN INEVITABLE, SHOULD BE CARRIED OUT BY A SKILLED PERSON WHO IS AWARE OF THE HAZARD INVOLVED.

CAPACITORS INSIDE THE INSTRUMENT MAY STILL BE CHARGED EVEN IF THE INSTRUMENT HAS BEEN DISCONNECTED FROM ITS SOURCE OF SUPPLY.

e-VF

ELECTRONIC VON FREY

Cat. No. 38450

General

Ugo Basile introduces an electronic apparatus for applying light touch to the rodent foot, the **e-VF, Electronic Von Frey**.

A touch stimulator transducer is mounted on a Perspex bar so that routine procedures may be employed to examine and test the animal skin sensitivity. A **prism** of proprietary design is a useful tool to locate and aim the stimulation area.

The completion of each test may be indicated either by the sudden release of the paw or by pressing the external foot-pedal. The display then gives the operator a summary of the results of the test (i.e. force and time corresponding to the animal response).

The operator may choose to reject the results or to accept them, in which case they are recorded in the e-VF internal memory. The results of several hundred tests may be stored in the e-VF for transfer them to a PC when convenient.

The rate of application of the force is set by the operator and the **NEW** e-VF includes software tools that help in consistently applying the force at the desired rate.

PAIN and INFLAMMATION



Sensitivity

Allodynia

ASSESSMENT OF
HYPERSENSITIVITY
IN RATS & MICE

Main Features

- DCA Software included - **NEW 2014 release**
- Maximum Applicable Force: 1000g
- Resolution: 0.1g
- Automatic recording of animal response
- User-controlled application of force rate
- Location of the target via the original prism-design



CHECK-LIST

Cat. No. 38450 e-VF Electronic Von-Frey

CLIENTE / CUSTOMER _____

Ordine No. / Order No. _____ Data / Date ____/____/____

UB code	CAT.No.	✓	Q.ty	DESCRIPTION	DESCRIZIONE
	38450-001		1	ELECTRONIC UNIT	UNITA' ELETTRONICA
	38450-004		1	TOUCH STIMULATOR TRANSDUCER	STIMOLATORE/TRASDUTTORE
	38450-310		1	GLASS PRISM	PRISMA
	38450-323		1	PEDAL SWITCH	PEDALE
52010-325			1	USB LEAD	CAVO USB
E-AU 059			1	UNIVERSAL POWER SUPPLY	ALIMENTATORE UNIVERSALE
E-AU 041	DCA		1	SOFTWARE	SOFTWARE
USB pen-drive	38450-302			INSTRUCTION MANUAL	MANUALE D'ISTRUZIONE
OPTIONAL					
	37450-278			BASE AND PLATFORM ASSY.	ASSIEME BASE E PIATTAFORMA
	37450-005			PERFORATED METAL SHEET	PIATTAFORMA PERFORATA

DATE / /	Serial No.	IMBALLATO DA / PACKED BY
Universal Input 85-264 VAC, 50-60Hz		

IMPORTANT/IMPORTANTE:

Check the shipment for completeness immediately after receipt: should you find any discrepancy, please fill in the following part and transmit it to our fax no. +39 0332 745488

Al ricevimento della merce controllate che la spedizione sia completa: in caso di discrepanza, completate il formulario di seguito riportato ed inviatelo al nostro fax no. 0332 745488

FROM: Name	Company/Institution
DATE	REF.

NOTE

CONTENTS

1	GENERAL	1
1.1	RATIONALE OF THE TECHNIQUE	1
1.1.1	<i>CONSISTENT RESULTS</i>	2
2	INSTRUMENT DESCRIPTION	2
2.1	ELECTRONIC UNIT	3
2.2	TOUCH STIMULATOR TRANSDUCER	4
2.3	THE OPTIONAL BASE PLATFORM / PERFORATED SHEET ASSEMBLY	4
3	DATA ACQUISITION	5
4	INSTALLATION	6
4.1	UNPACKING & PRELIMINARY CHECK	6
4.2	NOTES ON THE INSTRUCTION MANUAL	6
4.3	CHARGING THE INTERNAL BATTERY	6
4.4	CONNECTIONS	6
4.5	INSTALLING THE DCA SOFTWARE	7
4.6	INTENDED USE	7
4.7	GENERAL SAFETY INSTRUCTIONS	7
4.8	ADDITIONAL SAFETY CONSIDERATION	7
5	OPERATION	8
5.1	CONSIDERATION ON THE ANIMAL BEHAVIOR	8
5.2	FIRST TIME OPERATION	8
5.2.1	<i>AUTOMATIC DIMMING OF THE DISPLAY</i>	10
5.3	ROUTINE OPERATION OF THE INSTRUMENT	11
5.3.1	<i>TURNING ON THE E-VF</i>	11
5.3.2	<i>MENU OPERATION</i>	11
5.3.3	<i>TURNING OFF THE E-VF</i>	11
5.4	MAIN MENU	11
5.5	MEASURE MENU	12
5.5.1	<i>MEASURE PEAK FORCE</i>	12
5.5.2	<i>VIEW ACQUIRED DATA</i>	13
5.5.3	<i>TRANSFER DATA TO PC</i>	14
5.5.4	<i>CHANGE MAX FORCE</i>	14
5.5.5	<i>MEMORY STATUS</i>	14
5.5.6	<i>ERASE MEMORY</i>	14
5.5.7	<i>BACK TO MAIN MENU</i>	15
5.6	CONFIGURE MENU	15
5.6.1	<i>CONFIGURATION OPTIONS</i>	15
5.6.2	<i>RESTORING DEFAULT VALUES</i>	16
6	OTHER IMPORTANT FEATURES OF THE E-VF	17

6.1	BATTERY VOLTAGE WARNING	17
6.2	MEMORY LIMIT WARNING	17
6.3	CALENDAR CLOCK	17
6.4	APPLIED FORCE RATEMETER	18
6.5	AVAILABLE CONFIGURATION SETTINGS	18
6.6	UPDATING THE E-VF FIRMWARE	19
6.7	SKIPPING THE INTRODUCTION	19
7	USING THE PC SOFTWARE FOR E-VF	20
7.1	NOTE ON THE GSM PC SOFTWARE	20
7.2	STARTING THE DCA SOFTWARE	20
7.3	STARTING THE EXPERIMENT	21
7.3.1	MAIN BOX	21
7.3.2	INFO PANEL	22
7.3.3	DEVICE CONTROL PANEL	22
7.3.4	ANALYSIS CONTROL PANEL AND NOTES TOOL	22
7.3.5	ACCESSORIES	24
7.4	EXPORTING AND SAVING DATA	24
7.5	SLOPE FUNCTION	25
7.5.1	CHANGING THE SLOPE	26
7.6	DOWNLOADING DATA FROM GSM TO PC	26
8	MAINTENANCE	27
8.1	CLEANING THE PRISM	27
8.2	LONG INACTIVITY	27
8.3	CUSTOMER SUPPORT	28
9	ORDERING INFORMATION	28
9.1	OPTIONAL	29
10	INSTRUMENT SPECIFICATIONS	29

FIGURE INDEX

Figure 1	“Electronic Unit”	3
Figure 2	“Touch Stimulator Transducer”	4
Figure 3	“Optional Base/Platform 38450-278”	4
Figure 4	“Optional Enclosure”	5
Figure 5	“DCA Software”	20
Figure 6	“Test Monitoring”	21
Figure 7	“Analyze Window”	23
Figure 8	“Test Monitoring”	24

e-VF Electronic Von Frey

Cat. 3 8 4 5 0

1 GENERAL

Ugo Basile introduces an electronic apparatus for applying light touch to the rodent foot, the **e-VF, Electronic Von Frey**.

The e-VF has been designed to make sensitivity experiments easy and consistent.

A touch stimulator transducer is mounted on a perspex bar so that routine procedures may be employed to examine and test the animal skin sensitivity.

The completion of each test may be indicated either by the sudden release of the paw or by pressing the external foot-pedal. The display then gives the operator a summary of the test results

The rate of application of the force is set by the operator and the e-VF includes software tools that help the operator in consistently applying the force at the desired rate. The results of, typically, several hundred tests may be stored in e-VF for transfer to a PC when convenient.

The results of, several hundred tests may be stored in e-VF for transfer to a PC when convenient.

1.1 Rationale of the technique

Impaired cutaneous sensation is usually first manifested in a loss of light touch detection. The Electronic Von Frey was developed to quantify light touch in the laboratory animal.

The classic instrument for test of touch sensitivity is the Von Frey hair or, more specifically, the Semmes- Weinstein set of Von Frey Hairs, i.e., 20 monofilaments in a linear scale of physical force.

The hair is pressed against the skin, the force applied increases with increasing hand pressure, until the hair bends; once the hair is bent, increasing hand approach causes further bend, but negligible additional force on the skin. In this way, a given filament always applies the same force, not subject to variation by the energy of the operator.

The Semmes-Weinstein set can be used on rodents (which respond to light touch of the paw, if they feel it, by a paw withdrawal reflex). However, the involved procedure is tedious and time-consuming because several stimulations must be performed for a single test (i.e. a different filament for each force level).

Compared to the classic Von Frey Hairs, the **Electronic Von Frey device (e-VF)** has the advantage of ensuring a continuous force application along the whole force capacity of the sensor, by using a rigid metal tip, and the capability to record the animal response automatically.



Speaking about force, although the sensor can detect forces from 0 to 1000g, it is reasonable to set the device lower limit to 5g, given by difficulty, even for the most skilled user, to apply forces below this threshold.

Moreover, the metal tip used in the e-VF is the same as the one used in the classic **Ugo Basile Dynamic Plantar Aesthesiometer** (PN 37450), allowing consistent comparison of results among the two instruments.

1.1.1 Consistent Results

The PAM device has been designed to make sensitivity experiments easy and consistent, thanks to its:

- Effective **peak detector**, for a reliable and automated detection of the animal response
- **Rate-Meter** (see paragraph-6.4) and Slope features (see paragraph 7.5), ensuring the desired force is applied at a consistent rate
- **Software**, acting as a quality control tool, by showing the applied force (red line) and the desired target force rate (blue line) in real time.

The rate of application of the force (**target force rate**) is set by the operator from the configuration menu (see section 5.6.1, option 1) and the eVF includes software tools that help the operator in consistently applying the force at the desired rate.

See the below screenshot of the software showing the force trace (**in blue**) and the desired target force rate (**in black**).

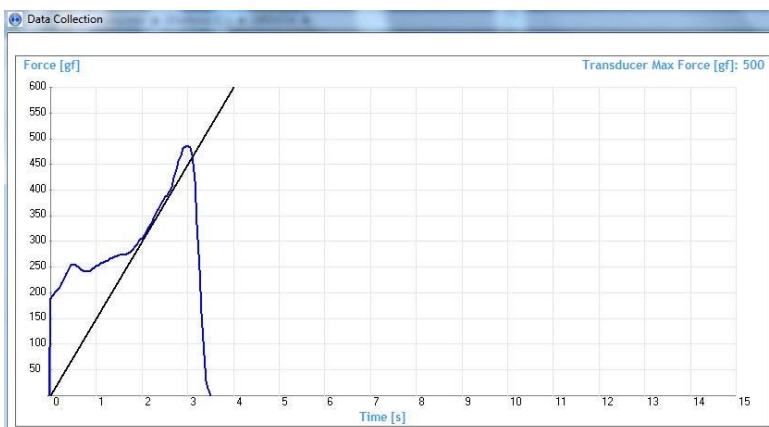

The experimenter can consistently apply the force at the desired rate, by simply making sure that the blue trace lays on the black line.

2 INSTRUMENT DESCRIPTION

The **38450** e-VF device comes as a complete package including:

- an Electronic Unit **38450-001**

- a Touch Stimulator Transducer **38450-004** with Glass Prism 38450-310
- a USB flash drive with driver, **DCA Software** and manual.
- an External trigger foot pedal **38450-303**

The instrument is delivered in a convenient plastic case which should be retained for the safe storage of e-VF and its accessories.



Beside the above listed items, the case also contains

- USB Cable **52010-325**
- Power adapter **E-AU 059**

and the instrument's Operating Manual 38450-302. See also paragraph 9-ORDERING INFORMATION.

The perforated platform featured in the picture is an optional accessory, see paragraph 9.1-Optional.

2.1 Electronic Unit

The e-VF electronic unit is lodged in a compact box. The three buttons below the display are **soft buttons** whose function changes at different stages of the e-VF program.

The e-VF is switched **ON** by pressing the **ON/OFF** button.

The lower line of the e-VF display, 4 by 20 character, is normally used to indicate the current function of each button.

When the e-VF is switched **ON**, the initial menu choice is between making measurements and configuring the instrument to suit the user's specific requirements.

The electronic unit is battery operated: its internal rechargeable battery is charged automatically when external power is supplied to its miniature USB 'B' socket, either from a PC or from a suitable USB power adapter.



Figure 1 "Electronic Unit"

A fully charged battery will operate e-VF continually with its display at maximum brightness for approximately 16 hours.

When the e-VF is switched **OFF**, it goes into a standby mode in which it takes almost no current from the battery although it still updates its internal calendar clock.

Prior to any measurements, e-VF automatically balances out any offsets using its **Auto-zero** function.

A relevant feature of the e-VF electronics is the **Ratemeter**, see paragraph 6.4, which provides a visual cue to make sure that the desired force is applied at a consistent rate.

The electronics stores results of several hundred tests, which can be transferred to a PC when convenient.

The detailed menu options will be described later, see paragraph 5.4, 5.5 and 5.6.

2.2 Touch Stimulator Transducer

The Touch Stimulator Transducer incorporates a probe (filament) to stimulate the animal paw at a user-controlled application of force rate.

The metal tip used in the e-VF is the same as the one used in the **UB Dynamic Plantar Aesthesiometer 37450**, allowing consistent comparison of results among the two instruments.

The glass prism is very useful for an easy location of the aimed stimulation area.

As each e-VF transducer has a built-in identification chip, e-VF is able to interrogate each transducer and adjust its own internal specification to match that of the transducer.



Figure 2 "Touch Stimulator Transducer"

2.3 The Optional Base Platform / Perforated Sheet Assembly

To ease the measurement on the plantar surface, we have designed the optional base assembly **37450-278**.

A **Perforated Metal Sheet (37450-005)**, inserted into a consistent frame, is held in place by its own weight on the top of four supporting columns, over a **metal base**, dimensioned 90(w) x 38.5(d) x 3.5(h) cm, made of enamelled aluminium.

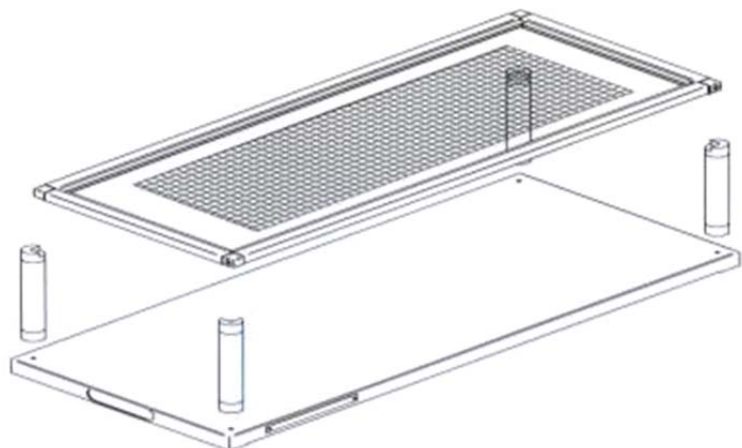

Figure 3 "Optional Base/Platform 38450-278"

The modular **Enclosure 37000-006** of original design, which completes the assembly, combines 3 animal cages.

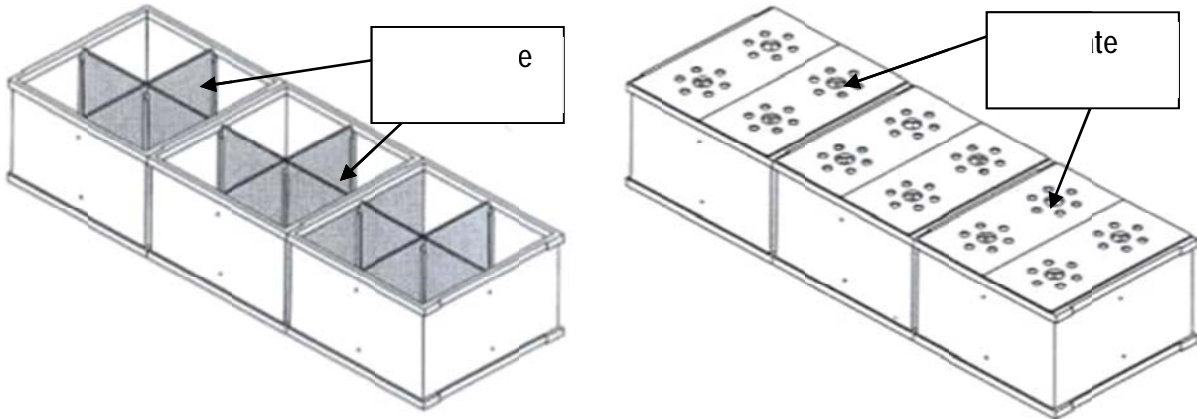

Figure 4 "Optional Enclosure"

Removable partitions enable the user to divide each of the 3 cages into 2 or 4 spaces, thus obtaining **up to 12 spaces**. Six separate lids make it easier to deposit/remove the rats individually. The cage dimensions are 17 (d) x 69 (l) x 14 (h) cm. The enclosure is duly positioned on the framed perforated sheet by the spacers provided.

In alternative, self-standing perforated metal sheets, provided with 40 or 80cm supporting legs are also available. They can be completed with the 37000-006 animal enclosure.



The base assembly is not included in the standard package and should be purchased separately. See paragraph 9.1-Optional.

3 DATA ACQUISITION

The **DCA software** provided with the instrument (on the USB pen-drive) ensures automatic recording and storing of the animal response

The software includes the Slope feature, to help the operator via a visual cue in consistently applying the force at the desired rate.

The results of several hundred tests may be stored in e-VF for transfer to a PC when convenient, see paragraph 7.6-Downloading Data from GSM to PC.

4 INSTALLATION

4.1 Unpacking & Preliminary Check

Check the contents of the shipment for completeness, packing list to hand, and visually inspect the instrument as soon you take it out of the packaging. Use the supplied **Check List**.

If the instrument is damaged, inform the carrier immediately, notifying our company. If after having tested it, the e-VF fails to meet rated performances, please contact our after sales service, see paragraph 8.3-Customer Support.



Protect the environment!

Dispose of packaging properly, according to existing and applicable waste management rules and regulations.

4.2 Notes on the Instruction Manual

The 38450 Instruction Manual included in the package (on the USB drive) is necessary for the correct installation and operation of the instrument.

We recommend reading the manual with attention, as it is essential for the correct installation and operation of the instrument.

Please save the manual, ready to be consulted by the qualified personnel who use the instrument. Print it, only if necessary.

Our Instruction Manuals are available as free download on our web. For any additional information and/or assistance, you are welcome to contact our Service Department (see paragraph 8.3-Customer Support), specifying the serial number of your instrument.

4.3 Charging the Internal Battery

The instrument is dispatched from the factory with a fully charged battery.

However, it is recommended that the battery is charged before initial use by connecting it to a USB socket on a functioning PC or to a suitable power adapter, using the USB cable provided, for at least 3 hours.

4.4 Connections

Plug the touch-stimulation transducer and the foot pedal into the connectors located on the back panel of the e-VF electronic unit.

4.5 Installing the DCA Software



ATTENTION:

Before installing the software, please read the INSTALLATION NOTES at the beginning of the manual.

The software provided with the Grip Strength Meter (on the USB pen drive) should be installed on a suitable Windows PC, running Windows Vista, 7, 8 or XP.

First, install the software. by double-clicking on the Start Ugo Basile.exe file; follow the instructions until installation is complete.

Then, connect the eVF via a USB port. The eVF will be automatically recognized and the drivers will install automatically, by simply following the instructions on the screen.

The Ugo Basile DCA Software can now be launched from the desktop icon or from the Program Files folder.

See section 7, for instructions on how to use the Ugo Basile DCA Software.

4.6 Intended Use

The eVF is intended for investigation use on laboratory animals only.

4.7 General Safety Instructions

The following guidelines must be followed to ensure safe operation.

- ! **DO NOT** attempt to open or perform any service work
- ! **DO NOT** connect up human subjects



4.8 Additional Safety Consideration

- a. Use original accessories and spare parts only, see also paragraph 9-ORDERING INFORMATION.
- b. Do not operate the instrument in hazardous environments or outside prescribed environmental limitations (i.e. +18C°/+24C°, 60% relative humidity, non-condensing);
- c. Do not spray any liquid on the connectors;
- d. Keep inflammables far from the instruments.

UGO BASILE DOES NOT ACCEPT ANY RESPONSIBILITY FOR PROBLEMS OR HARM CAUSED TO THINGS OR PERSONS, ARISING FROM:

- incorrect electrical supply;
- incorrect installation procedure;

- incorrect or improper use or, in any case, not in accordance with the purpose for which the instrument has been designed and the warnings stated in the instruction manual supplied with the instrument;
- replacement of original components, accessories or parts with others not approved by the manufacturer;
- servicing carried out by unauthorized personnel, see also paragraph 8-MAINTENANCE.

5 OPERATION

5.1 Consideration on the Animal Behavior

The e-VF device is a simple and easy-to-use device. As usual in any behavioral measurement, care must be taken by the operator to guarantee a consistent performance of the test.

When using the e-VF, we can envisage two main potential sources of experimental variability: the first is the animal emotional state, which can be overcome by preliminary habituation procedures and the second is the rate at which the operator applies the force.

The e-VF device incorporates several tools to help the operator consistently apply the desired amount and rate of force on the animal, the **ratemeter** on the electronic unit display, and the **slope function**, on the software, see also paragraph 1.1.1. These tools are described in the following paragraphs.

These tools are described in the following paragraphs.

5.2 First Time Operation

After charging the e-VF for at least 3 hours, plug in the touch-stimulation transducer and turn the instrument **ON** by pressing the **ON/OFF** button.



Once the introduction screen is completed, the initial menu will appear as below.

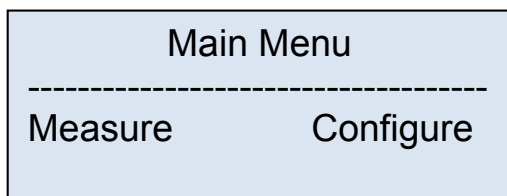

The lower line of the display indicates the current functions of the three **soft buttons** labelled F1, F2 and F3.

In this case, F1 is **Measure**, F2 is not being used and F3 is **Configure**.

Press **Measure**. A screen similar to the following will appear:

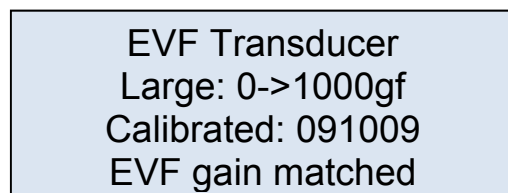

After a few seconds, the instrument completes an **Autozero** operation and then the display shows:

Note that, in this case, all three **soft buttons** are in use.

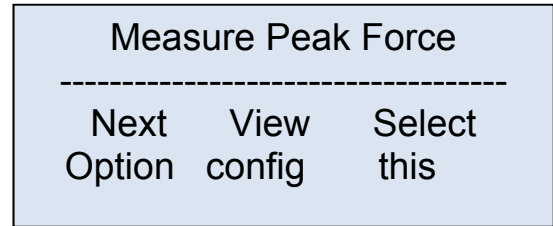

IMPORTANT NOTE:

Do not apply force while the instrument is carrying out the autozero procedure.

Press **Select this**.

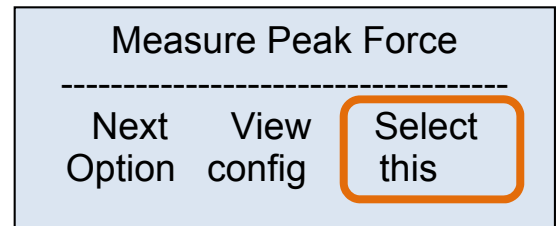

The following display will appear:

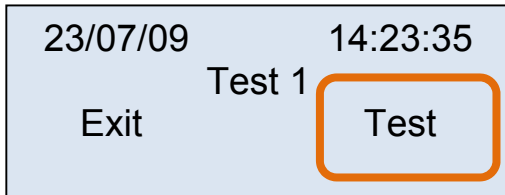

Check that no force is being applied to the connected transducer and then press **Test**.

e-VF checks the transducer zero and then displays:

For as long as the force is applied steadily, the **Force** value will indicate the applied force in gf and the **Time remaining** will indicate the number of seconds left to complete the test.

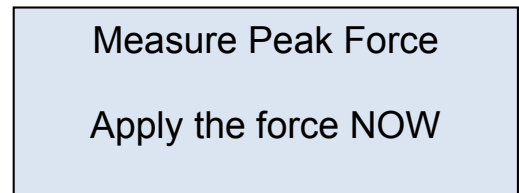

When the transducer is released, the screen changes, and showing the peak force and the reaction time in seconds (over a total measurement time, in seconds).

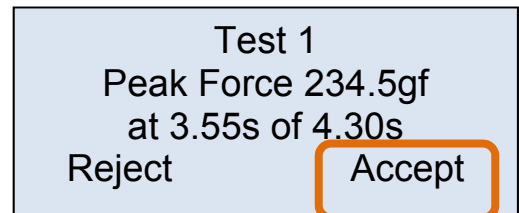

Press **Accept** and the screen changes to:

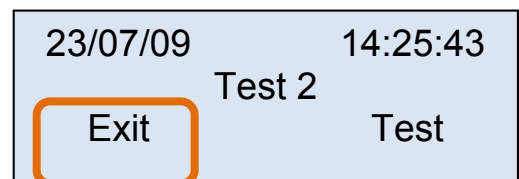

While pressing **Exit** the display returns to:

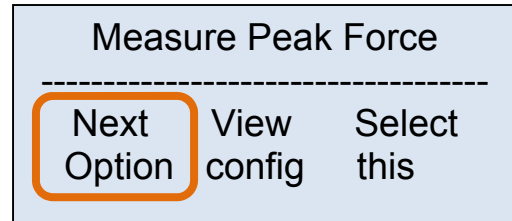

Press **Next option**, then press **Select this**.

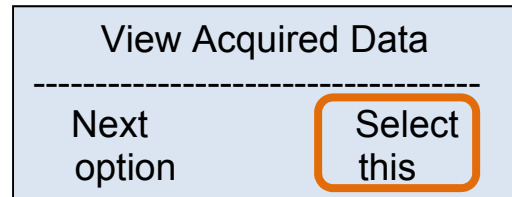

The stored data will be loaded and after 1-2 seconds the display shows:

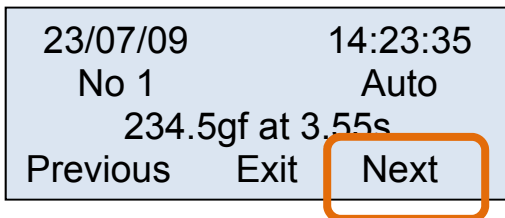

The most relevant information of each measurement (Date, Time, Progressive number of the measurement, Automatic or Foot Pedal measurement mode, Peak Force, Peak Time) are shown and the measurements can be browsed by simply pressing **Next**.

Press **Exit** to return to:

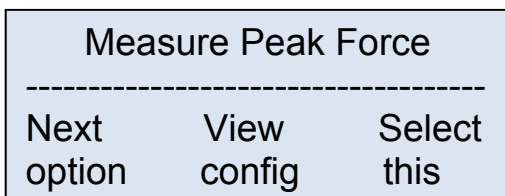

Press the **ON/OFF** button to switch OFF the e-VF.

NOTE : If the e-VF does not behave as described, please repeat all the steps.

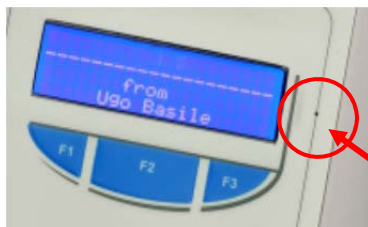

If the problem remains, charge the internal battery and reset the e-VF manually by pressing with a needle into the small reset hole located to the right of the display.

5.2.1 Automatic Dimming of the Display

The display backlight may be configured to dim automatically in most menus, if no soft button is pressed during a period preset between 2s and 29s.

By default this feature, which extends the battery life, is OFF and may be turned ON from the Configuration Menu.

5.3 Routine Operation of the Instrument

5.3.1 Turning ON the e-VF



The e-VF is turned **ON**, by pressing the **ON/OFF** button.

5.3.2 Menu Operation

E-VF is operated via a number of menus by pressing the three **soft buttons**, F1, F2 and F3 under the display.

The current functions of F1, F2, F3 are indicated by the lower line/s on the display.



For example, the following is a typical display in the **Measure** menu:

Measure Peak Force		
Next option	View config	Select this

The user steps through the available option (which appear on the upper line) by pressing “**Next option**” and then selects the desired option by pressing “**Select this**”.

5.3.3 Turning OFF the e-VF



E-VF may be turned **OFF** from most display screens, by pressing the **ON/OFF** button.

To preserve battery life, e-VF switches **OFF** automatically, after a period of inactivity (if no soft button is pressed), which can be preset from **2 to 29** minutes or **never**, from the **Configure** menu; the factory default setting is **never**.

E-VF also switches **OFF** automatically if the battery voltage is below a critical level.

5.4 Main Menu

The **Main Menu** is the first menu which appears when e-VF is switched ON.

Main Menu	
Measure	Configure

Via the “**Measure**” menu, see paragraph 5.5 it is possible to chose the options relating to measurements and transferring collected data are to the PC.

The “**Configure**” menu allows the user to adjust a number of parameters to suit particular measurement requirements, see paragraph 5.6.

5.5 Measure Menu

When Measure is selected from the Main Menu, a screen appears which is similar to the following, and depends on the force selected.

EVF Transducer
 Large: 0->1500gf
 Calibrated: 091009
 EVF gain matched

After a few seconds, e-VF completes an **Autozero** procedure and the following screen is displayed:

Measure Peak Force

Next option	View config	Select this
----------------	----------------	----------------

This is the initial screen of the **Measure** menu which consists of the following 6 options, which appear in a loop:

- Measure Peak Force
- View Acquired Data
- Transfer Data to PC
- Change Max Force
- Memory Status
- Erase Memory

Press **Next option** to go to the following option; press **View config** to view the configuration in use.

These options are discussed in the next sub-headings. The descriptions given refer to factory-set default values for the configuration settings. The effects of altering these settings will be discussed later.

5.5.1 Measure Peak Force

Pressing **Select this** at the **Measure Peak Force** screen gives a display similar to:

24/07/09	15:46:09	
	Test 4	
Exit		Test

which shows the current date and time, the next test number (in the example the test will be the fourth to be stored since e-VF's memory was last erased) and the options "Exit" and "Test".

When **Test** is pressed, a caption will appear, intimating that no force be applied to the transducer during the autozero procedure, after which the fol-

Measure Peak Force
 Apply the force NOW

lowing display:

The user should now perform the measurement.

As soon as the initial force threshold is reached, the display shows:

Acquiring Force Data
 Force = 123.4gf
 Ends on force level
 Time remaining 10.2s

The **Force** shows the currently applied force in gf while **Time remaining** counts down in 0.05s steps from the Maximum measurement time, which may be adjusted up to 30s (default 15s).

Normally, the test is terminated either by releasing the force on the transducer (default) or (optionally) by pressing the external foot switch.

In either case, the display shows typically:

Test 4
 Peak Force 293.6gf
 at 7.70s of 8.69s
 Reject Accept

The first figure, 7.70s indicates the peak time (*i.e.* the latency time of the animal response), while the second figure, 8.69s, indicates the total duration of the test. The user must choose whether to **Reject** or **Accept** the results of the test, by pressing the corresponding soft-button.

If the result is rejected, it is possible to stop the measurements or repeat the previous test. If the result is accepted, the data are stored in the e-VF memory and the user may stop the measurements or proceed with another test.

If the **Maximum measurement time** is exceeded during the test, the measurement is terminated automatically and the display shows:

Measurement time
 was exceeded
 Begin Repeat
 again test

Pressing **Begin again** effectively returns the user to the first Measure Peak Force screen, while pressing **Repeat test** allows the user to repeat the current test.

5.5.2 View Acquired Data

Select **View Acquired Data** from the **Measure** menu, followed by **Select this**; the total number of stored measurements will be displayed, and then the following screen will appear, with data related to the last measurement:

16/09/09 10:34:15
 No 1 Auto
 234.5gf at 3.55s
 Previous Exit Next

Press **Previous** to view the test before the one being displayed. If the first measurement was displayed, as in this example, pressing **Previous** will display test 70, as the test numbers loop.

Press **Next** to view the next stored measurement, **Exit** to return to option 1 of the Measure menu (*i.e.* Measure Peak Force).

5.5.3 Transfer Data to PC

Via this option it is possible to transfer the data stored in e-VF's memory to the PC, see paragraph 7.6 for instruction.

The e-VF must be connected to the PC via the USB cable supplied and that the PC is running the appropriate DCA software provided with the instrument.

If this option is selected in the absence of a PC, correctly connected and running appropriate software, e-VF displays "**PC not available**" for a few seconds and then returns to the first option on the Measure menu.

For detailed software details and instruction, see paragraph 7.

5.5.4 Change Max Force

This option enables the user able to change the maximum force applied. Press **Select this**.

Change Max Force		
Next option	Exit	Select this

The display shows the available Max Force values; the underscoring indicates the currently selected force.

Press **Change** to chose a different force value, followed by OK, to confirm the selection.

Available Max Force		
50gf	200gf	1000gf
Exit	OK	Change

Exit will bring you back to the first option of Measure menu.

5.5.5 Memory Status

Select the **Memory Status** option from the Measure menu to check the e-VF data memory available to store further measurements; in the following example: 75.4%.

Memory Status Available 75.4% Tests left: >547 Back
--

The estimated value of **>547** for **Tests left** is based on the assumption that future measurements will be similar in length to those already stored.

The number of tests that can be stored, strongly depends on the duration of each test.

Press **Back** to return to the first option of the **Measure** menu.

5.5.6 Erase Memory

When selecting **Erase Memory** from the **Measure** menu, you will be given the option to cancel all the data stored in the memory, by pressing **Confirm**.

Erase memory All stored data will be lost	
Cancel	Confirm

The configuration settings will not be changed.

If you do not wish to cancel the data, press **Cancel** to return to the start of the **Measure** menu.

The **Erase Memory** option is offered automatically after transferring the data to the PC, see paragraph 7.6.

5.5.7 Back to Main Menu

To go back to the main menu, press **Exit**. When the Exit choice is not available, press Next Option, until Exit appears over the F2 soft-button.

5.6 Configure Menu

When **Configure** is selected from the **Main Menu**, the following screen appears, which allows the user, by pressing **Set config**, to adjust a **number of configuration settings in e-VF**.

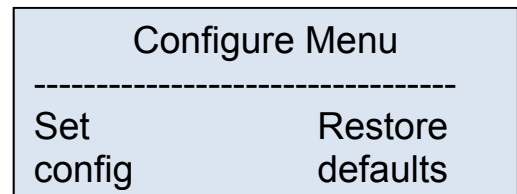

These include **options related to the measurement process**, such as whether the measurement is ended automatically by removing the applied force or manually by pressing the foot trigger switch, but also covers more **general settings**, such as the brightness of the display and the period of inactivity before e-VF will switches off.

An example:

by pressing **Set Config**, the first configuration option appears, from which the user chooses between ending the measurement automatically or by pressing the Foot Pedal.

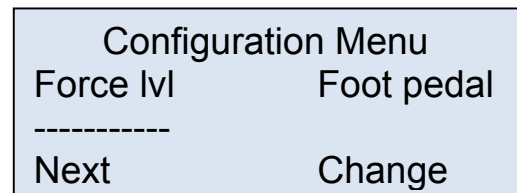

The underscoring under **Force lvl** indicates that the **end on force level** option (factory default) is selected.

Pressing **Change** moves the selection to **Foot pedal**. There is no need to confirm the choice; press **Next** to see the next configuration option.

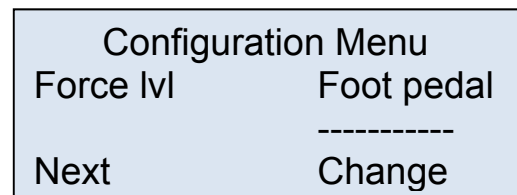

5.6.1 Configuration Options

The **Configure** menu shows 17 screens in a loop, by which the user may adjust the following features of e-VF in order to:

- 1) Adjust the target force rate (**120gf/s**)
- 2) Use Ratemeter or Text (**Text**), see also paragraph 6.4
- 3) Set how each measurement is ended, automatically when reaching the force level, or by pedal switch (**force lvl**)
- 4) Set a warning sound to inform if a preset force is exceeded (**none**)

- 5) Adjust the warning sound threshold value (**300gf**)
- 6) Adjust the force value which triggers the start of the measurement (**2% of full scale**)
- 7) Adjust the maximum time allowed for a measurement (**15s**)
- 8) Set if the operator should be asked Left or Right paw at each test (**Do not**)
- 9) Use Subject Numbers or only Test numbers (**only Test**)
- 10) Store every measurement regardless or only the good measurements, *i.e.* accepted by the user (**only good**)
- 11) Store the force waveform or only the peak value (**waveform**)
- 12) Show abbreviated configuration settings on the Measure menu (**Do not**)
- 13) Show the offset value before each measurement (**Do not**)
- 14) Adjust the period of inactivity after which e-VF switches OFF, from 2 to 29 minutes, or never (**never**), see also paragraph 5.3.3
- 15) Adjust the normal (undimmed) display brightness (**10**)
- 16) Adjust the period of inactivity after which the display dims, from 2s to 29s, or never (**never**) see also paragraph 5.2.1
- 17) Set current date and time: this can be set by the e-VF control unit or by the PC, see also paragraph 6.3.

The values in the brackets are the factory default settings. See also 6.5-Available Configuration Settings.

Press **Exit** to return to the Main Menu: **you will be asked to save Changes to Configuration.**

5.6.2 Restoring Default Values

From the Configure Menu, it is possible to restore the factory default values; press **Restore defaults** and the following screen will be displayed:

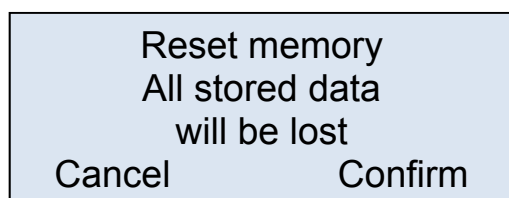

Pressing **Cancel** returns to the **Main Menu** without altering the configuration settings nor the data memory.

Press **Confirm** to restore the factory-set configuration values as indicated in paragraph 5.6.1.

Remember that this action will also clear the data memory!

6 OTHER IMPORTANT FEATURES OF THE e-VF

6.1 Battery Voltage Warning

The voltage of the internal rechargeable battery used in the e-VF is monitored continuously during routine operation. Two warning levels are provided.

If the battery is low but still usable, the dashed line of most menus will include **Battery Low**. For example, the first **Measure** screen will become:

Measure	Peak	Force
----Battery Low----		
Next	View	Select
option	config	this

The e-VF may still be used, but the USB lead should be connected to an active PC or a USB power adapter to charge the battery as soon as possible.

If the battery is so low that e-VF cannot operate, then the instrument will switch OFF immediately. The data which have been stored will be retained but e-VF cannot be used until it is connected to an active PC or a USB power adapter using the USB lead provided.

Clearly, it is not advisable to allow the battery to drop to this critical level.

6.2 Memory Limit Warning

Each time the user decides to make a new measurement, the e-VF checks that sufficient data memory is available.

If the available memory is too low, the request is refused and the user is advised to transfer the stored data to a PC and/or to erase the existing data; in practice, this critical situation should never arise as **the user is given a clear warning each time a measurement is made** if the available space is not sufficient for 10 more measurements.

The e-VF memory stores more than 1700 tests.

6.3 Calendar Clock

E-VF has an internal calendar clock which maintains real time even while e-VF is switched off. To set the e-VF clock, go to the Configure menu, see paragraph 5.6.1, item 17).

When the supplied PC software is used to transfer data or to monitor the force applied to the transducer, the e-VF internal clock is synchronised automatically to the PC clock, see also paragraph 7.

6.4 Applied Force Ratemeter

The Ratemeter is a useful tool, which helps the operator in consistently applying the force at the desired constantly-increasing rate.

If the **Ratemeter** option is selected from the Configure menu (see paragraph 5.6.1, item 1), during each measurement, the e-VF's display will appear as follows:

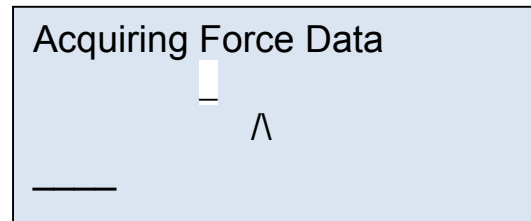

The **white rectangle** on the second line moves left or right of the **centre marker**, when the applied force is respectively below or above that required to maintain the selected force rate.

In the above example, the applied force is below the ideal level for the specified target force rate.

The fourth line of the display is a **time progress bar** indicating how much of the available measurement time has been used.

The software Slope feature (see 7.5) can be used in alternative, with the same purpose.

6.5 Available Configuration Settings

A complete list of configuration options is shown below including the adjustment ranges and default values, see also paragraph 5.6.1-Configuration Options.

Configuration flags which may be set or cleared.

- Whether each measurement is ended automatically on the **force level** (default) or by pressing the **foot pedal**.
- Whether **every measurement** is stored regardless (sometimes required by GLP) or the user may **choose which measurements** to store (default).
- Whether **the transducer offset value is shown** before each measurement or **not** (default).
- Whether **a warning sounds** if a preset **force is exceeded during** a measurement or **not** (default).
- Whether **abbreviated configuration settings** are shown on the Measure menu or **not** (default).
- Whether the stored data includes the **force waveform** (default) or **not**.
- Whether the operator should be asked to **indicate Left or Right limb** or **not** (default).
- Whether e-VF should use **Subject Numbers** or **not** (default).

- Whether e-VF should use the applied **force ratemeter** during tests or display **live force and time in text** (default).

Configuration values which may be adjusted:

- The **force value** (as a percentage of the full scale range) **which triggers the start** of the measurement. It may be adjusted from **0.4% to 5.0% in 0.1% steps** with a default value of 2%.
- The **threshold force** value in gf **which triggers the warning**, if enabled. It may be adjusted from **100gf to 1000gf in 10gf steps** with a **default value of 300gf**.
- The **maximum time** allowed for a measurement. It may be adjusted from **10s to 30s in 1s steps** with a **default value of 15s**.
- The **period of inactivity** after which **e-VF switches OFF**. It may be adjusted from **1min to 29min in 1min steps** or **never** with a default value of never.
- The normal (undimmed) **display brightness**. May be adjusted from **1 to 10** with a default value of 10.
- The **period of inactivity** after which the **display dims**. May be adjusted from **1s to 29s in steps of 1s** or **never** with a default value of never.
- The **target force rate** which is the ideal rate at which the stimulus force should be applied, see also paragraph 6.4)
- The **date and time settings** of e-VF's internal clock may be adjusted manually. The internal clock is normally set by synchronising it with the PC to which it is attached. Synchronising occurs when data is downloaded from e-VF to the PC and when force measurements are monitored live on the PC.
- **Return to main menu**. This **menu** option acquires the latest configuration information and returns to the initial menu.

6.6 Updating the e-VF firmware

The hardware used in e-VF is very flexible and many of e-VF features are determined by its internal software program or firmware, as it is often called.

When improvements and additions are made to the firmware, existing users may update easily to the new version. The associated PC software includes an option to update the e-VF firmware.

6.7 Skipping the introduction

The routine introduction shown when e-VF is turned ON may be skipped by holding down the left soft button.

7 USING THE PC SOFTWARE FOR E-VF

This section assumes that the **DCA PC** software has been installed successfully as described in paragraph 4.5.

The DCA software manages the GSM, the PAM and eVF instruments by Ugo Basile.

7.1 Note on the GSM PC Software

The DCA software is a guide: specifically, this software is a **monitoring tool** and it is not intended to drive the device (the software does not substitute for the controller); all operations must therefore be driven from the GSM control unit.

This includes changing the slope of the GSM target rate displayed on the PC monitor, which is in fact done from control unit. In fact the slope function on the PC reflects the Target force rate set in the configuration menu, see paragraph 5.6.1.

7.2 Starting the DCA Software

First connect the GSM device to the PC using the supplied USB cord, then run the **Ugo Basile DCA (Data Collection Application) Software** program from the Windows Start Menu or from the DCA icon on the desktop.

In the screen which appears, the Info Panel informs “**Device found**”:

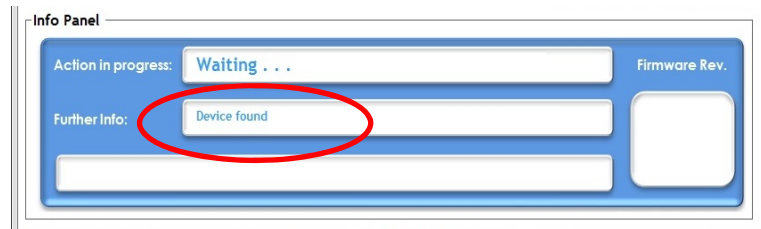

To proceed with the experiment press the “**Use Device**” button.

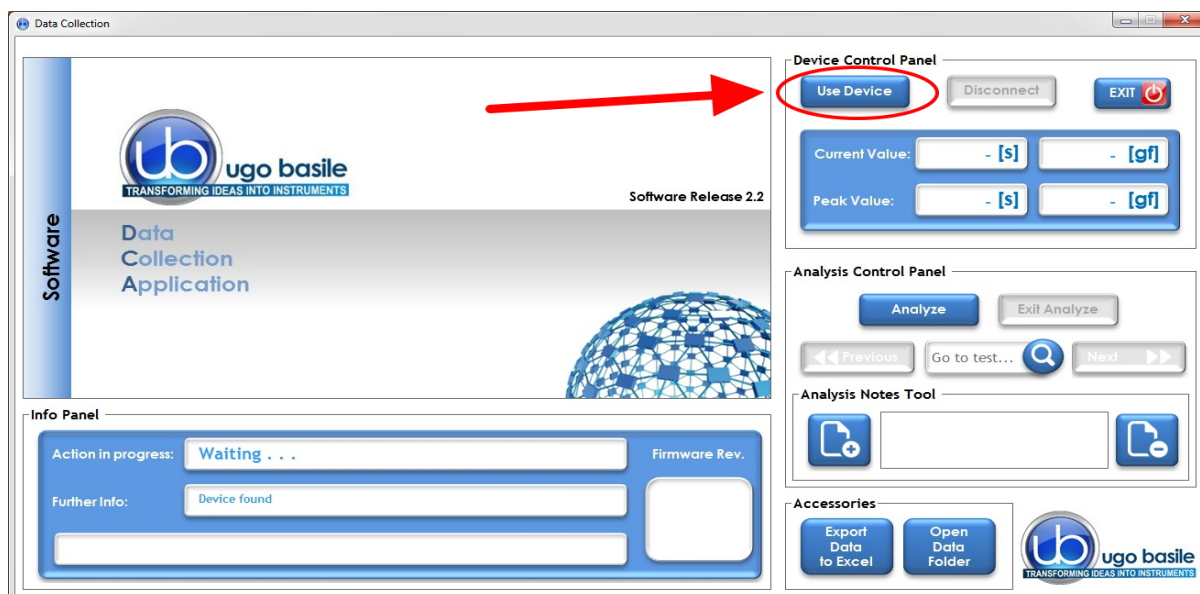
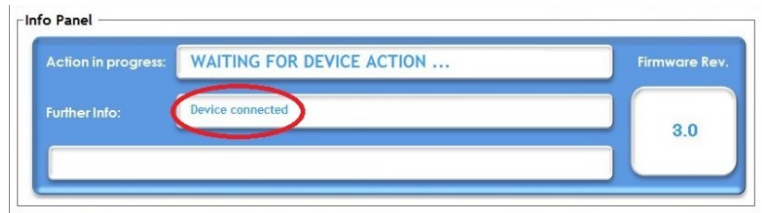

Figure 5 “DCA Software”

Wait until the info Panel confirms “device connected”.



7.3 Starting the Experiment

Now that the software is ready to work, the test-monitoring window will appear:



Figure 6 “Test Monitoring”

The test-monitoring window includes the following sections:

7.3.1 Main Box

As soon as the experiment is started from the device, the main box on the left will continuously plot the applied force intensity along time.

Note that the applied force appears as a **blue line**, overlapping a straight black line: the latter indicates the desired target force rate, as set via in the instrument configuration menu (slope feature)

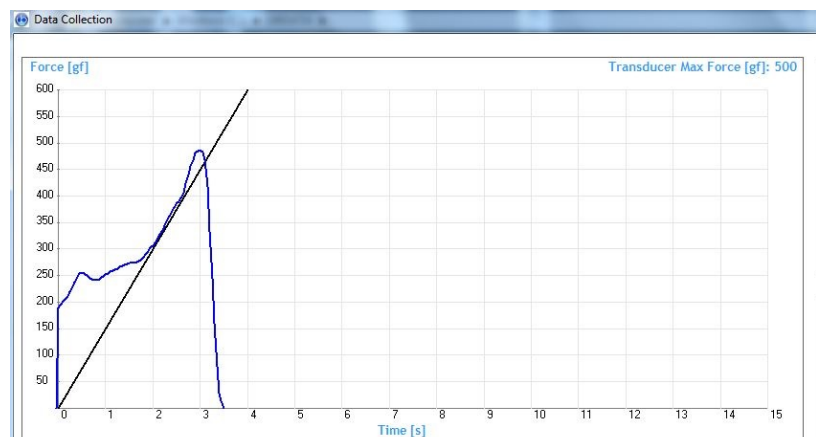

See paragraphs 1.1.1-Consistent Results and 7.5-Slope Function.

This function helps the experiment to apply the force consistently, by simply making sure that the blue trace lays on the black line.

At the beginning of each new trial, the plot window refreshes so that just the current and latest one is visualized.

A caption on the top right of the window reminds the Transducer Max Force, as set in the instrument configuration menu.

7.3.2 Info Panel

The Info Panel indicates the action in progress (in these examples TEST MONITORING, and WAITING) and additional information regarding the action

In addition, the panel shows the current Firmware revision.

During the data Analysis, the panel shows specific data related to the selected file



7.3.3 Device Control Panel

From the Control Panel it is possible to start the software (USE DEVICE) or to disconnect it (DISCONNECT).

The current value and the overall peak are displayed in the related boxes, together with the time.

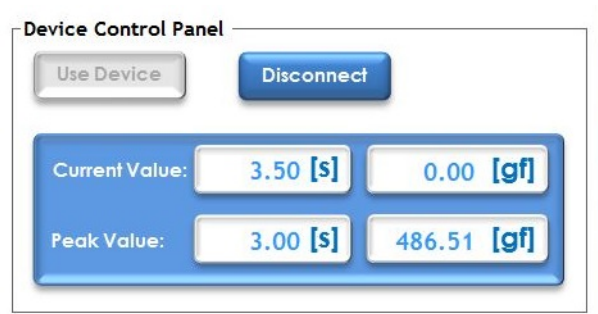

7.3.4 Analysis Control Panel and Notes Tool

All data files are stored in the folder **C:\UB Data** in sub-folders which are named according to the date of data transfer, in the format **YYMMDD**; for example, data transferred on July 23rd, 2013 will be found in the folder **C:\UB Data\130723**. All the trials conducted in the same experiment are saved in the same file.

Individual files, containing the downloaded data, are named automatically according to the date, followed by two letters which progress from **AA, AB, AC...** through to **ZZ**.

For example, the third set of data downloaded on July 23rd, 2013 would be stored in the file:

C:\UB Data13\090723AC.PAM

where “PAM” is the extension of this proprietary software.

During the test, the Analysis panel is not active



Once the experiment is over and the data transmitted from the device to the computer, push the button “**Analyze**” to open the folder where the .PAM files are saved and stored during the test. Select the file from the window which automatically appears:

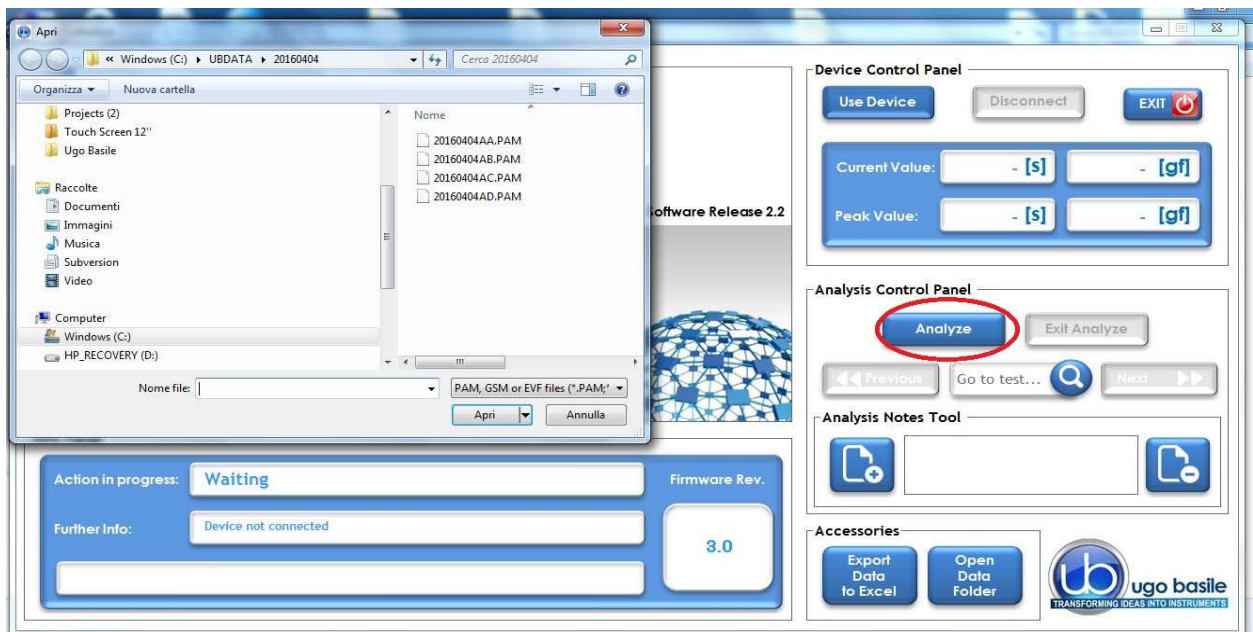

Figure 7 “Analyze Window”

When opening the selected file, all the plots referring to the trials contained in the related experiment will be shown:

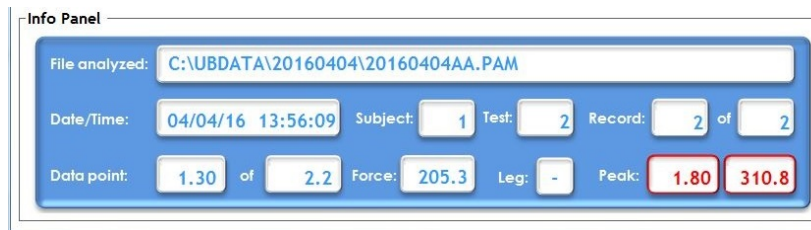
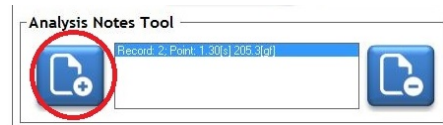

Figure 8 "Test Monitoring"

By moving the **black vertical line** (indicated by the arrows in the above screenshot) left or right along the slope, the user will be able to select a specific moment in the test.

To save it, select the "Add Note" button, left on the "Analysis Notes Tool".

The note is remove by the button on the right.



Note that the Info Panel now shows the data relating to the point currently selected.

Moreover, the recorded peak measure is pointed out, associated with time.

7.3.5 Accessories

In this section you will find the Export Data to Excel and the Open Data Folder buttons.



7.4 Exporting and saving data

Once the analysis of the experiment is accomplished, it is possible to export the data to Excel or to open a data folder.



While the DCA PC software is not designed for statistical analysis, exporting the data using the DCA PC software creates a user friendly file compatible with Excel. One will find this automatically generated file to be most useful, because Excel seems to be the most common spreadsheet program which allows a researcher to perform whatever analytical statistics are preferred.

The data in the Excel file consists of columns for measurement number, peak force and peak position, filled with the values for each of the test downloaded.

When all the operations and experiments are completed, it is recommended to click “Disconnect” from the “**Device Control Panel**”, in order to close the connection between the device and the software.

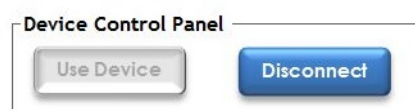

7.5 Slope Function

By the “Slope” function, the experimenter can consistently apply the force (i.e. pull the animal) at the desired rate, by simply making sure that the blue trace lays on the black line, see paragraphs 1.1.1 and 7.3.1.

The graphic screen is a visual guide during the experiments; the applied force is displayed as a blue line, while the straight black line (slope) shows the target force rate set from the device configuration menu, see paragraph 5.6.1, option 1.

The target force is also indicated in the Info Panel, 150gf/s in this example.



The slope represents what it looks like when the force is applied in a linear increasing rate; one should think of the slope as the **ideal**, the “target” that the user should try to match as s/he is applying the force. Matching the two lines will assist an operator in applying the force smoothly and steadily; this is what we call “**slope function**”.

With practice, a researcher can become very skilled at steadily applying force, at a steadily increasing rate of application of the force, and really improve results.

The waveform is displayed until the user Accepts or Rejects the test, by using the buttons on the GSM control unit.

7.5.1 Changing the Slope

Remember, the GSM controller is the brain of the instrument and the software is only reporting information in the brain; the GSM PC software displays information provided by the GSM instrument. As the slope is the visual representation of the rate of application of force, to change the slope of the blue line in the software, one must change the rate of application of force.

This rate is stored in the GSM controller, so one must return to the GSM controller, toggle through the selected menus to reach the proper instructions. When the rate of application of force is changed in the internal memory of the GSM controller, it will automatically change the slope of the blue line which is displayed in the software.

7.6 Downloading Data from GSM to PC

When working with the GSM not connected to the PC, all the data are stored inside the device memory. Data can be saved on the PC; data download is also controlled by the GSM device.

First, ensure that the controller is properly connected to the PC, and that the software is working properly.

Then, using the menu and buttons on the GSM controller, toggle through selections (**Main Menu > Measure > Next Option**) until the Transfer Data to PC appears on the blue display window of the GSM controller.

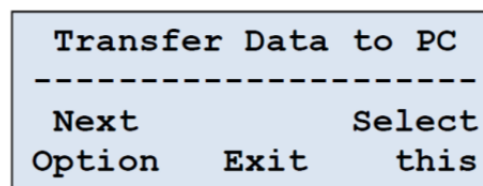

A progress bar in the Info Panel of the DCA software monitors the download: the same panel will confirm when the data download is complete.

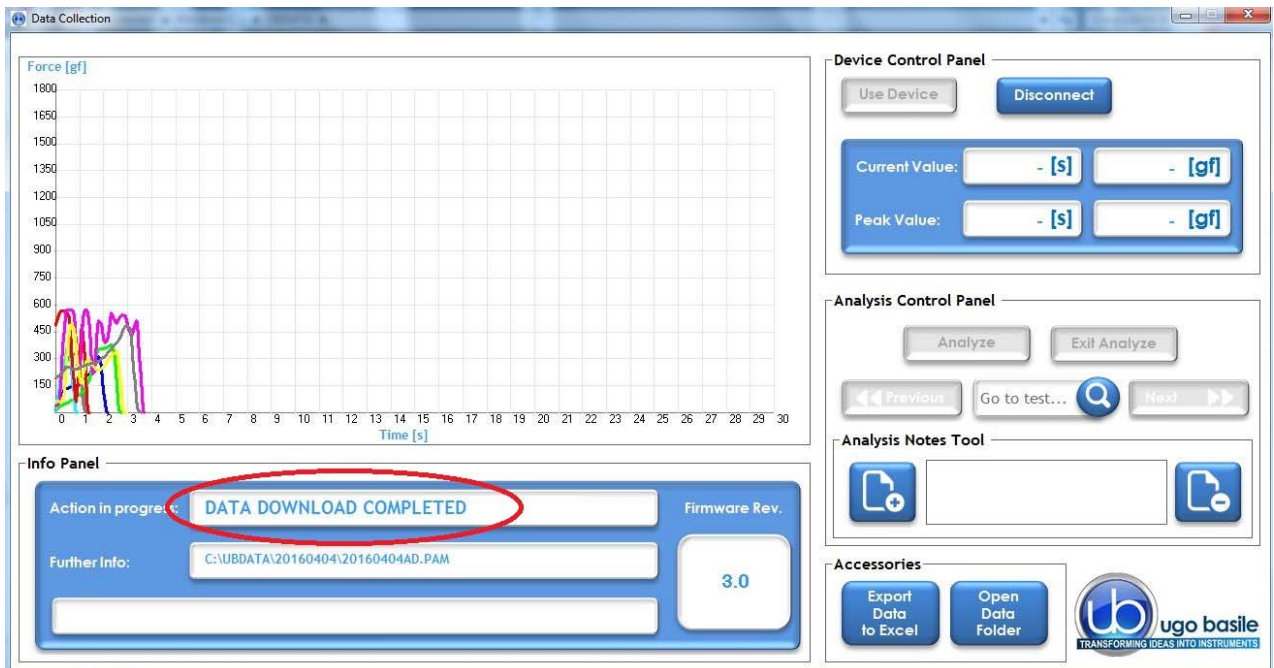

Data can now be analyzed as described in paragraph 7.3.4



The **Transfer Data to PC** operation, also ensures that the GSM clock and the PC clock are synchronized.

If this is performed when the GSM has no stored data, it will only synchronize the GSM and PC clocks.

8 MAINTENANCE

While any service of the instrument ought to be carried out by Ugo Basile personnel or by qualified personnel authorized by UGO BASILE organization, this section of the instruction manuals describes normal maintenance procedures which can be carried out at your facility.

8.1 Cleaning the Prism



Pay attention when handling the Prism: it's extremely fragile!

Dust, fingerprints, traces of animal faeces and urine on the prism surface may obviously degrade its reflectiveness.

Clean the prism after each session with mild detergent.

8.2 Long Inactivity

The instrument does not require any particular maintenance after long inactivity.

8.3 Customer Support

For any further information you may desire concerning the use and/or maintenance of the eVF, please do not hesitate to contact our **service department** (or our local distributor) either directly or via our support page <http://www.ugobasile.com/support.html> :



UGO BASILE s.r.l.

Via G. Di Vittorio 2
21036 GEMONIO – Varese, ITALY



Phone : +39 0332 744574



service@ugobasile.com
logistics@ugobasile.com
sales@ugobasile.com

Before sending any instrument to our factory for repair, please contact our logistics department to obtain a return authorization number (RMA) and shipping/packing instructions.

We may not be held responsible for damages during transport due to poor packing; whenever possible, please use the original packing.

9 ORDERING INFORMATION

38450	EVF Electronic Von Frey consisting of:
38450-001	Electronic Unit
38450-004	Touch Stimulator Transducer, with handle, including
	38450-310 Glass Prism
	38450-330 Filament, with magnetic fixing
38450-323	External trigger switch (foot pedal)
52010-325	USB Lead
E-AU 059	Universal Power Supply
E-AU 041	USB pen-drive, including
	38450-302 Instruction Manual
DCA	Software

9.1 Optional

- 37450-278 Base assembly for plantar stimulation, including support with columns, perforated metal sheet and multiple-configuration animal-enclosure, from 3 to 12 spaces.
- 37450-005 Large Perforated Metal Sheet
- 37450-045 Large Perforated Metal Sheet, with 4 legs, 40cm height (animal enclosure 37000-006 is not included and should be ordered separately)
- 37450-085 Large Perforated Metal Sheet, with 4 legs, 80cm height (animal enclosure 37000-006 is not included and should be ordered separately)

10 Instrument Specifications

Operation	
Commands	via soft-buttons
Read-out	multifunction graphic display
Starting	via keys on the Controller front panel
Force Range	Up to 1000 grams (maximum force can be preset)
Force increasing rate	monitored via the Ratemeter on the electronic unit, or via the slope function on the PC
Latency Time	read-out on the graphic display, in 0.1 s steps
Connection to PC	via USB cable (A to mini-B)
Power Requirement	either battery operated, or via USB cable connected to PC or universal converter (85-264 VAC, 50-60Hz)
Operating Temperature	10° to 40° C
Sound Level	negligible
Pollution Degree	≤ 2
Physical	
Total Weight	0.8 Kg
Shipping Weight	2.7 Kg approx.
Packing Dimensions	46 x 38 x 27 cm
Warranty	
38450 is covered by a 24-month warranty	



CE CONFORMITY STATEMENT

Manufacturer **UGO BASILE srl**
Address Via G. di Vittorio, 2 – 21036 Gemonio, VA, ITALY
Phone n. +39 0332 744574
Fax n. +39 0332 745488

We hereby declare that

Instrument. **eVF ELECTRONIC VON FREY**
Catalog number **38450**

*It is manufactured in compliance with the following European Union Directives
and relevant harmonized standards*

- *2004/108/CE relating to electromagnetic compatibility*
EN 61000-3-2, EN 61000-3-3, EN 61000-6-1, EN 61000-6-2, EN 61000-6-3, EN 61000-6-4.
- *2011/65/UE on the restriction of the use of certain hazardous substances in electrical and electronic equipment*

Account Manager

Adriano Basile

Nome / Name

April 2014

Date

Firma / Signature