

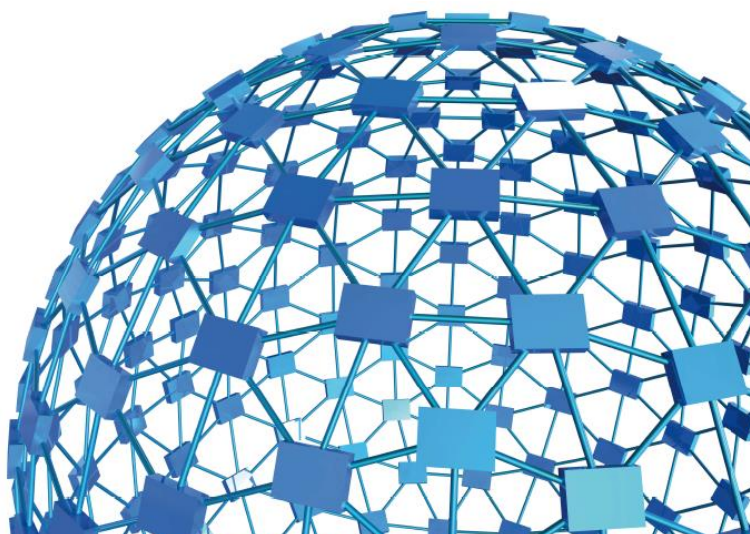

**ugo basile<sup>®</sup>**

# **instruction manual**

**Dynamic Plantar Aesthesiometer  
Cat. No. 37450**



**UGO BASILE S.R.L.**

[sales@ugobasile.com](mailto:sales@ugobasile.com) / [service@ugobasile.com](mailto:service@ugobasile.com) [www.ugobasile.com](http://www.ugobasile.com)

**UGO BASILE S.R.L.**

Via Di Vittorio, 2  
21036 GEMONIO, VA, ITALY  
Phone: +39 0332 744574

sales@ugobasile.com / service@ugobasile.com  
www.ugobasile.com

**instruction manual**

**Dynamic Plantar Aesthesiometer  
Cat. No. 37450**

Serial No.

## **SAFETY CONSIDERATIONS**

**ALTHOUGH THIS INSTRUMENT HAS BEEN DESIGNED WITH INTERNATIONAL SAFETY STANDARD, THIS MANUAL CONTAINS INFORMATION, CAUTIONS AND WARNINGS WHICH MUST BE FOLLOWED TO ENSURE SAFE OPERATION AND TO RETAIN THE INSTRUMENT IN SAFE CONDITIONS.**

**SERVICE AND ADJUSTMENTS SHOULD BE CARRIED OUT BY QUALIFIED PERSONNEL, AUTHORIZED BY UGO BASILE ORGANIZATION.**

**ANY ADJUSTMENT, MAINTENANCE AND REPAIR OF THE OPENED INSTRUMENT UNDER VOLTAGE SHOULD BE AVOIDED AS MUCH AS POSSIBLE AND, WHEN INEVITABLE, SHOULD BE CARRIED OUT BY A SKILLED PERSON WHO IS AWARE OF THE HAZARD INVOLVED.**

**CAPACITORS INSIDE THE INSTRUMENT MAY STILL BE CHARGED EVEN IF THE INSTRUMENT HAS BEEN DISCONNECTED FROM ITS SOURCE OF SUPPLY.**

Instruction Manual dated July 2016  
Revision 1



# Dynamic Plantar Aesthesiometer

Cat. No. 37450

- Mechanical Stimulation
- With large platform
- Modular animal cage for Mice & Rats

**ASSESSMENT OF ANIMAL SENSITIVITY TO LIGHT TOUCH OF THE PAW**

## General

The Dynamic Plantar Aesthesiometer has been designed to assess **“touch sensitivity”** on the plantar surface of the rodents.

Somaesthetic (mechanical) stimulation has a long history of effective clinical use to diagnose pathologies of hyper- or hypo-aesthesia, brought about by drugs, neural pathology or experimental lesions, etc., in model and experimental systems using laboratory animals.

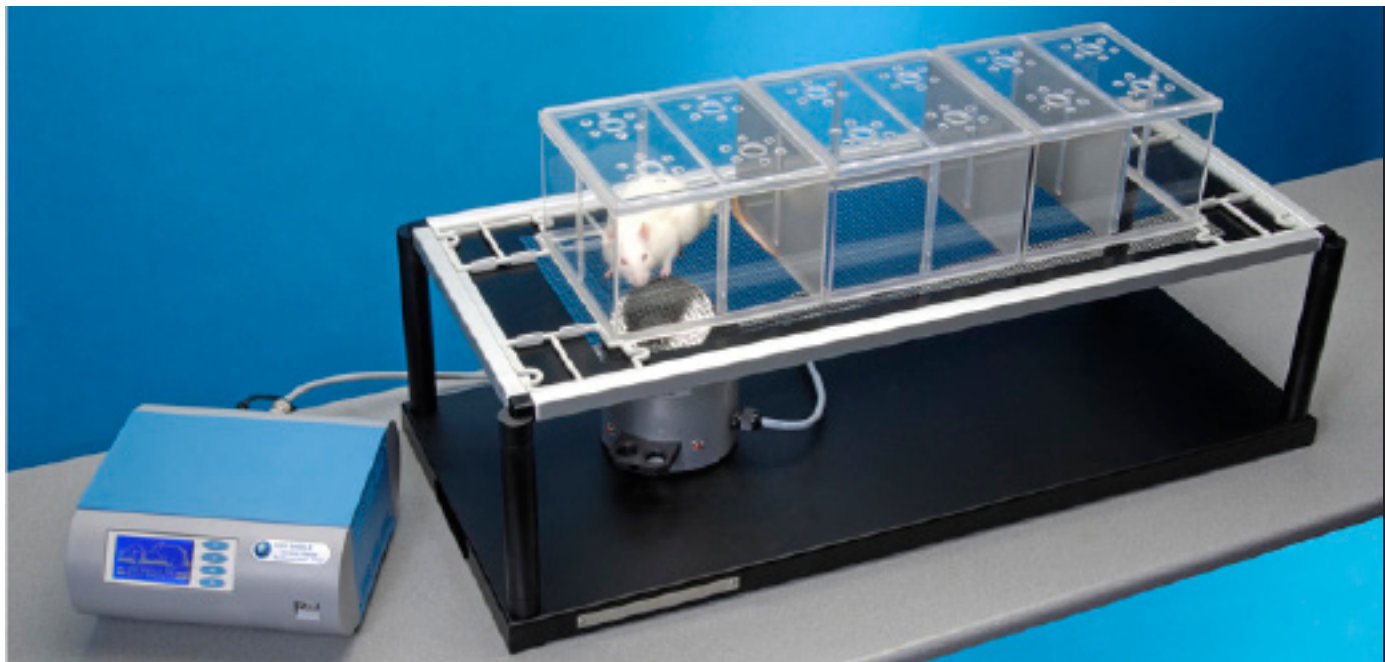

## Main Features

- Automatic detection of animal response (no visual score needed)
- Consistent application of force at an adjustable rate (force ramp)
- Software included as standard
- Data Portability via the Memory-Key provided with the standard package
- Print-out: by optional panel mount or independent thermal MiniPrinter
- NEW: orofacial stimulation by optional holders



## CHECK-LIST

**Cat. No. 37450 Dynamic Plantar Aesthesiometer**

CLIENTE / CUSTOMER \_\_\_\_\_

Ordine No. / Order No. \_\_\_\_\_ Data / Date \_\_\_\_ / \_\_\_\_ / \_\_\_\_

| UB code                | CAT.No.   | ✓ | Q.ty | DESCRIPTION   | DESCRIZIONE  |
|------------------------|-----------|---|------|---|--|
|                        | 37450-001 |   | 1    | CONTROL UNIT  | UNITÀ DI CONTROLLO   |
|                        | 37400-002 |   | 1    | TOUCH STIMULATOR  | UNITÀ DI STIMOLAZIONE TATTILE  |
|                        | 37000-003 |   | 1    | COMPLETE BASE   | BASE COMPLETA  |
|                        | 37400-327 |   | 4    | SUPPORTING COLUMNS  | COLONNE DI SUPPORTO  |
|                        | 37450-005 |   | 1    | FRAMED PERFORATED METAL SHEET   | PIATTAFORMA PERFORATA CON CORNICE  |
| 3 x M-S 085            | 37000-006 |   | 1    | MODULAR ANIMAL ENCLOSURE (3 MODULES)  | GABBIA MODULARE (3 MODULI)   |
|                        | 37450-321 |   | 1    | PLASTIC BLISTER, INCLUDING:<br>2 FILAMENTS<br>2 CALIBRATION WEIGHTS<br>1 HEX. WRENCH 1.25 | BLISTER, CONTENENTE:<br>2 FILAMENTI<br>2 PESI DI CALIBRAZIONE<br>1 CHIAVE BRUGOLA 1.25 |
| E-WP 008               |           |   | 1    | MAINS CABLE   | EUROPE<br>USA  |
| E-WP 008-1             |           |   |      |   | CAVO RETE<br>USA   |
| E-FF 002               |           |   | 2    | FUSES (2AF)   | FUSIBILI (2AF)   |
| E-AU 041 USB pen-drive | 37450-302 |   | 1    | INSTRUCTION MANUAL  | MANUALE DI ISTRUZIONE  |
|                        | 52050-12  |   |      | CUB SOFTWARE  | SOFTWARE CUB   |
|                        | 52010-323 |   | 1    | USB CABLE   | CAVO USB   |
| <b>OPTIONAL</b>        |           |   |      |   |  |
|                        | 37000-145 |   | 1    | PANEL MOUNT PRINTER   | STAMPANTE A PANNELLO   |
|                        | 37400-305 |   | 1    | PACKAGE OF 10 PAPER ROLLS   | PACCO DA 10 ROTOLI CARTA   |
|                        | 37450-278 |   | 1    | ADDITIONAL STIMULATION BASE   | BASE STIMOLAZIONE AGGIUNTIVA   |

|                                     |            |                          |
|-------------------------------------|------------|--------------------------|
| DATE / /                            | Serial No. | IMBALLATO DA / PACKED BY |
| Universal Input 85-264 VAC, 50-60Hz |            |                          |

### IMPORTANT/IMPORTANTE:

Check the shipment for completeness immediately after receipt: should you find any discrepancy, please fill in the following part and transmit it to our fax no. **+39 0332 745488**

Al ricevimento della merce controllate che la spedizione sia completa: in caso di discrepanza, completate il formulario di seguito riportato ed **inviatelo** al nostro fax no. **0332 745488**

FROM: Name \_\_\_\_\_ Company/Institution \_\_\_\_\_

DATE \_\_\_\_\_ REF. \_\_\_\_\_

**NOTE**

# CONTENTS

|          |  |           |
|----------|--|-----------|
| <b>1</b> | <b>GENERAL</b> .....                                   | <b>1</b>  |
| 1.1      | PRINCIPLE OF OPERATION .....                           | 1         |
| <b>2</b> | <b>INSTRUMENT DESCRIPTION</b> .....                    | <b>2</b>  |
| 2.1      | THE MOVABLE TOUCH STIMULATOR .....                     | 2         |
| 2.2      | THE PLATFORM/PERFORATED SHEET/ENCLOSURE ASSEMBLY.....  | 3         |
| 2.2.1    | ANIMAL ENCLOSURE .....                                 | 4         |
| 2.3      | CONTROLLER .....                                       | 4         |
| 2.3.1    | COMMAND DISPLAY MODULE .....                           | 4         |
| 2.3.2    | GRAPHIC DISPLAY .....                                  | 5         |
| 2.3.3    | KEYBOARD .....   | 5         |
| 2.3.4    | FUNCTION KEY ABBREVIATIONS .....                       | 5         |
| <b>3</b> | <b>DATA ACQUISITION &amp; DATA PRINT-OUT</b> .....     | <b>6</b>  |
| 3.1      | DATA PORTABILITY .....                                 | 6         |
| 3.2      | PANEL-MOUNT PRINTER 37000-145 .....                    | 7         |
| 3.3      | 57145 MINIPRINTER .....                                | 7         |
| <b>4</b> | <b>INSTALLATION</b> .....                              | <b>8</b>  |
| 4.1      | UNPACKING & PRELIMINARY CHECK .....                    | 8         |
| 4.2      | NOTES ON THE INSTRUCTION MANUAL .....                  | 8         |
| 4.3      | ASSEMBLING THE EQUIPMENT.....                          | 8         |
| 4.3.1    | TOUCH STIMULATOR .....                                 | 8         |
| 4.3.2    | ASSEMBLING THE PLATFORM .....                          | 9         |
| 4.3.3    | ASSEMBLING & POSITIONING THE ENCLOSURE .....           | 11        |
| 4.3.4    | HOW TO HANDLE THE DYNAMIC PLANTAR AESTHESIOMETER ..... | 11        |
| 4.4      | ENVIRONMENT .....                                      | 11        |
| 4.5      | BEFORE APPLYING POWER.....                             | 12        |
| 4.5.1    | FUSE HOLDER .....                                      | 12        |
| 4.5.2    | MAIN SWITCH .....                                      | 12        |
| 4.5.3    | MAINS CORD .....                                       | 12        |
| 4.6      | CONNECTIONS .....                                      | 12        |
| 4.6.1    | BACK PANEL .....                                       | 13        |
| 4.7      | INSTALLATION OF CUB SOFTWARE .....                     | 13        |
| 4.8      | INTENDED USE .....                                     | 14        |
| 4.9      | GENERAL SAFETY INSTRUCTIONS.....                       | 14        |
| 4.10     | ADDITIONAL SAFETY CONSIDERATION .....                  | 14        |
| <b>5</b> | <b>OPERATION</b> .....                                 | <b>15</b> |
| 5.1      | SWITCHING ON .....                                     | 15        |
| 5.2      | DISPLAY CONTRAST .....                                 | 15        |
| 5.3      | SETTING FORCE AND RATE APPLICATION .....               | 15        |
| 5.4      | CARRYING OUT THE TEST ON THE ANIMAL.....               | 16        |

|            |   |           |
|------------|---|-----------|
| <b>5.5</b> | <b>DURHAM HOLDERS FOR OROFACIAL STIMULATION .....</b>                 | <b>17</b> |
| <b>5.6</b> | <b>HOW TO SET A CUSTOMIZED EXPERIMENTAL CONFIGURATION.....</b>        | <b>18</b> |
| 5.6.1      | <i>SEQUENCE NUMBER</i>  | 18        |
| 5.6.2      | <i>EXPERIMENT NUMBER</i>  | 19        |
| 5.6.3      | <i>ANIMAL GENDER</i>  | 19        |
| <b>5.7</b> | <b>CONFIGURATION FILE .....</b>                                       | <b>19</b> |
| 5.7.1      | <i>FROM THE MEMORY KEY TO THE INSTRUMENT</i>                          | 20        |
| 5.7.2      | <i>UPLOADING</i>  | 20        |
| 5.7.3      | <i>DOWNLOADING</i>  | 20        |
| 5.7.4      | <i>FROM USB-KEY TO PC</i>   | 21        |
| 5.7.5      | <i>FROM PC TO INSTRUMENT</i>  | 21        |
| <b>6</b>   | <b>OPERATING WITH MINI PRINTER AND PC.....</b>                        | <b>21</b> |
| 6.1        | <b>HOW TO SET THE DATA OUTPUT TO PC .....</b>                         | <b>21</b> |
| 6.2        | <b>HOW TO SET THE DATA OUTPUT TO MINIPRINTER.....</b>                 | <b>21</b> |
| 6.3        | <b>DATUM FORMAT .....</b>   | <b>22</b> |
| 6.4        | <b>QUICK SETTING OF THE 37370 DYNAMIC PLANTAR AESTHESIOMETER.....</b> | <b>23</b> |
| <b>7</b>   | <b>MEMORY MANAGEMENT .....</b>  | <b>24</b> |
| 7.1        | <b>MEMORY RESET .....</b>   | <b>25</b> |
| 7.1.1      | <i>“MEMORY FULL” MESSAGE</i>  | 25        |
| 7.2        | <b>SETTING TIME &amp; DATE .....</b>                                  | <b>26</b> |
| <b>8</b>   | <b>CALIBRATION .....</b>  | <b>26</b> |
| <b>9</b>   | <b>MAINTENANCE.....</b>   | <b>27</b> |
| 9.1        | <b>ELECTRICAL.....</b>  | <b>27</b> |
| 9.1.1      | <i>BATTERY REPLACEMENT</i>  | 27        |
| 9.2        | <b>TOUCH STIMULATOR.....</b>  | <b>28</b> |
| 9.3        | <b>CLEANING THE MIRROR .....</b>                                      | <b>29</b> |
| 9.4        | <b>LONG INACTIVITY.....</b>   | <b>29</b> |
| 9.5        | <b>CUSTOMER SUPPORT .....</b>   | <b>29</b> |
| <b>10</b>  | <b>INSTRUMENT SPECIFICATIONS.....</b>                                 | <b>30</b> |
| <b>11</b>  | <b>ORDERING INFORMATION.....</b>                                      | <b>31</b> |
| 11.1       | <b>SPARE PARTS .....</b>  | <b>31</b> |
| 11.2       | <b>OPTIONAL .....</b>   | <b>31</b> |
| 11.3       | <b>THERMAL MINIPRINTER.....</b>                                       | <b>32</b> |
| <b>12</b>  | <b>BIBLIOGRAPHY.....</b>  | <b>32</b> |
| 12.1       | <b>PAPERS MENTIONING UB DYNAMIC PLANTAR AESTHESIOMETER.....</b>       | <b>32</b> |
| 12.2       | <b>DURHAM HOLDERS FOR OROFACIAL STIMULATION .....</b>                 | <b>33</b> |

**FIGURE INDEX**

*Figure 1 “Touch Stimulator”* ..... 3  
*Figure 2 “Perforated Metal Sheet”* ..... 3  
*Figure 3 “Panel-Mount Printer and USB Pen-Drive”* ..... 7  
*Figure 4 “Positioning the Probe”* ..... 9  
*Figure 5 “Assembling the Platform”* ..... 10  
*Figure 6 “Positioning the Touch Stimulator”* ..... 10  
*Figure 7 “Power Module”* ..... 12  
*Figure 8 “Back Panel”* ..... 13  
*Figure 9 “Test Manager Window”* ..... 22



# Dynamic Plantar Aesthesiometer

Cat. 37450

## 1 GENERAL

Ugo Basile introduces an **automated apparatus for applying reproducible light touch to the rodent foot**, the Dynamic Plantar Aesthesiometer 37450.

Impaired cutaneous sensation is usually first manifested in a loss of light touch detection. So “mechanical” stimulation has a long history of effective clinical use to diagnose pathologies of hyper- or hypo-aesthesia, brought about by drugs, neural pathology or experimental lesions, etc.

The Dynamic Plantar Aesthesiometer was developed to quantify light touch in the laboratory animal automatically.

The 37450 is a microprocessor-controlled unit, providing:

- direct connection to the PC USB and serial ports, via the dedicated software included as standard
- read-out on a multifunction liquid-crystal graphic-display
- data Portability via the Memory-Key provided
- print-out by optional panel mount or independent thermal mini-printer
- orofacial stimulation, by optional holders, see paragraph 5.5.
- universal mains 85-264 VAC, 50-60Hz

### 1.1 Principle of Operation

The classic tool to test of human touch sensitivity, to detect neural damage or drug action, is the VonFrey hair kit or, more specifically, the Semmes-Weinstein set of Von Frey Hairs, 20 monofilaments in a linear scale of physical force. The hair is pressed against the skin. The force applied increases with increasing hand pressure, until the hair bends.

Once the hair is bent, increasing hand approach causes further bend, but negligible additional force on the skin. In this way, a given filament always applies the same force, not subject to variation by the energy of the operator.

The Semmes-Weinstein set can be used on rodents, which respond to light touch of the paw, if they feel it, by a paw withdrawal reflex. However, it is necessary to hold the animal off the ground, with its paw available for contact.



The main advantages of the **Dynamic Plantar Aesthesiometer** over the classic manual filaments are:

- the measurement is continuous, i.e., you apply the increasing force with the same rigid filament until you see a response, rather than having to change filaments
- the operator does not personally apply the force, thus avoiding the human error, as it is the device to apply the force at the rate and intensity that the operator sets
- The 37450 allows the animal to be in an enclosed area, but unrestrained and untouched by the operator.

**The Ugo Basile Dynamic Plantar Aesthesiometer 37450 is the quickest and most accurate way of delivering a mechanical stimulation and measuring a response, all automatically!**

The 37450 basically consists of a touch stimulator which moves below a perforated metal platform upon which the operator deposits the animal, see picture.

A Perspex enclosure defines the space within which the animal is unrestrained. It is divided in three compartments, which help the operator to carry out a rapid “screening” work: up to 12 animals can be tested with no appreciable delay in between.

After the acclimation period, the touch stimulator is positioned by the operator directly beneath the hind paw. A trial is commenced by depressing a key, positioned on the stimulating unit. An additional start key is located on the front panel of the Controller.

When the animal feels pain and withdraws its paw, the withdrawal latency to the nearest 0.1s is automatically determined and recorder.

## 2 INSTRUMENT DESCRIPTION

The Instrument consists of:

- 1) a movable **Touch Stimulator**, see paragraph 2.1
- 2) a **framed Perforated Metal Sheet** on its base platform complete with 4 columns see paragraph 2.2
- 3) a modular **Animal-Enclosure** Assembly, see paragraph 0
- 4) a **Controller** lodged in a cabinet of original design, incorporating a **Command/Display Module**, see paragraph 2.3.

### 2.1 The Movable Touch Stimulator

The **Touch Stimulator 37400-002** is housed in a cylindrical vessel of aluminium, fitted with a handle, which the operator glides over the surface of the base platform (see the leaflet picture and Figure 1).

At both sides of the handle, a START key is provided, to help both left and right handed operators.

The vessel incorporates an electrodynamic actuator of proprietary design which lifts a straight, 0.5mm diam. probe (filament) of NiTi alloy.

The probe is provided with a miniature plastic “umbrella”, to avoid infiltration of urine & faeces, which could cause the pushing mechanism to jam in the long run.

The actuator probe produces force over the entire range of all typical aesthesiometer test devices.

An adjustable angled-mirror is provided to help the user aiming the target area of the paw. Act on the mirror adjust. handle to find the most suitable inclination.

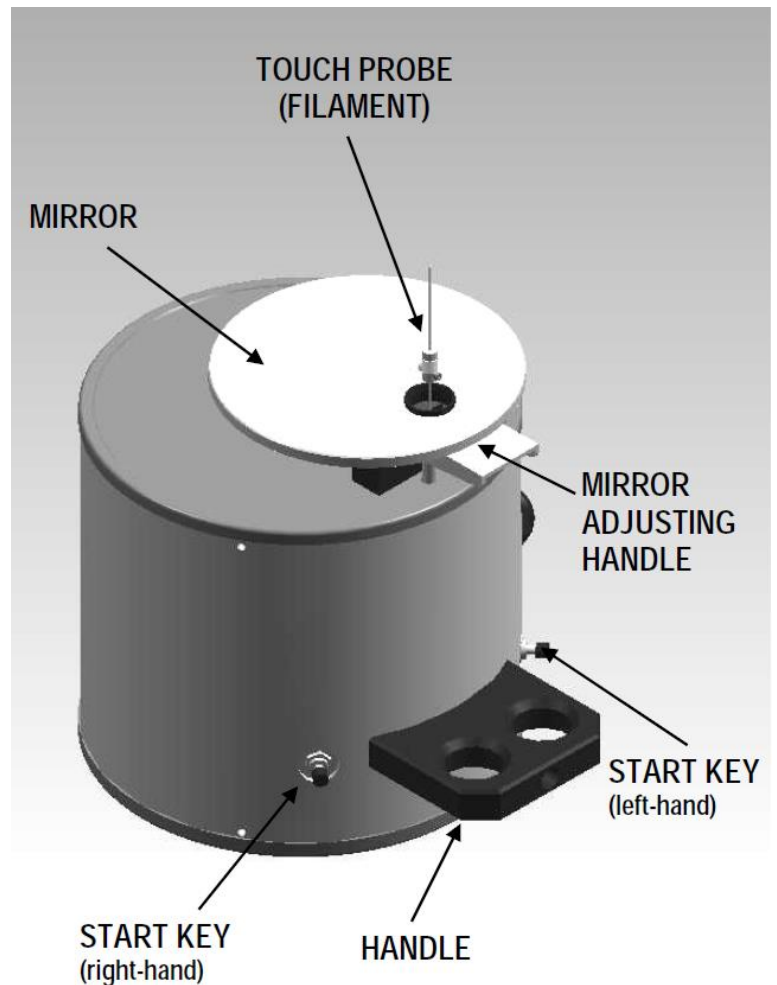

*Figure 1 “Touch Stimulator”*

## 2.2 The Platform/Perforated Sheet/Enclosure Assembly

The Touch Stimulator glides on the large base platform **37000-003**.

A Perforated Metal Sheet **37450-005**, inserted into a consistent frame dimensioned 90(w)x38.5(d)x3.5(h)cm, is held in position by its own weight on the top of four supporting columns **37400-327**, tightened at the platform corners. See also Figure 5 “Assembling the Platform”

Laser-cut perforations form a mesh-like open grid of square holes 5x5 mm; the metal between the holes is about 1mm thick.

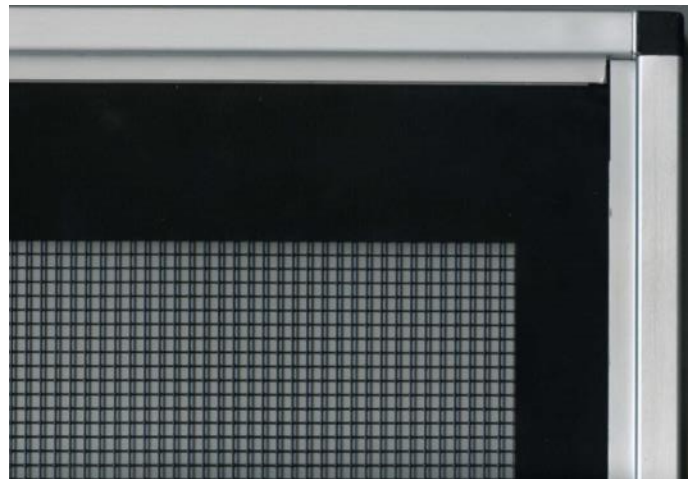

*Figure 2 “Perforated Metal Sheet”*

### 2.2.1 Animal Enclosure

A modular enclosure **37000-006** of original design, combines 3 animal cages.

Removable partitions enable the user to divide each of the 3 cages into 2 or 4 spaces, thus obtaining **up to 12 spaces**.

The enclosure is duly held in position on the framed glass pane, by the spacers provided.

Six separate lids make it easier to deposit/remove the rats individually.

The cage dimensions are approx. 20(d)x62(w)x14(h)cm.

Each of the 3 compartment is hence dimensioned 20x20x14(h)cm.

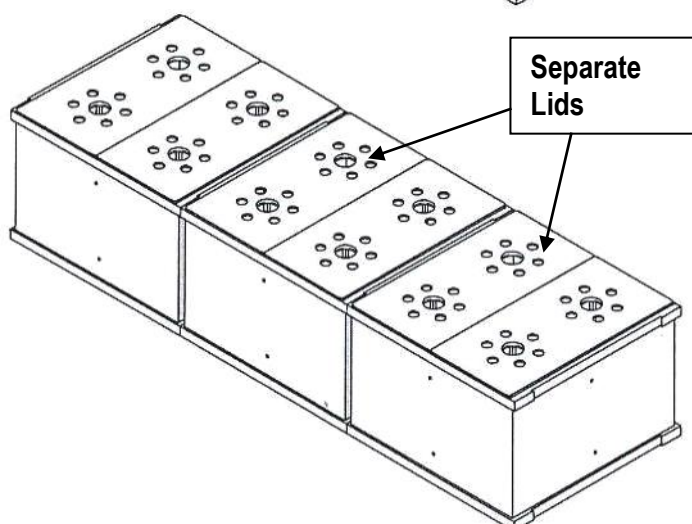
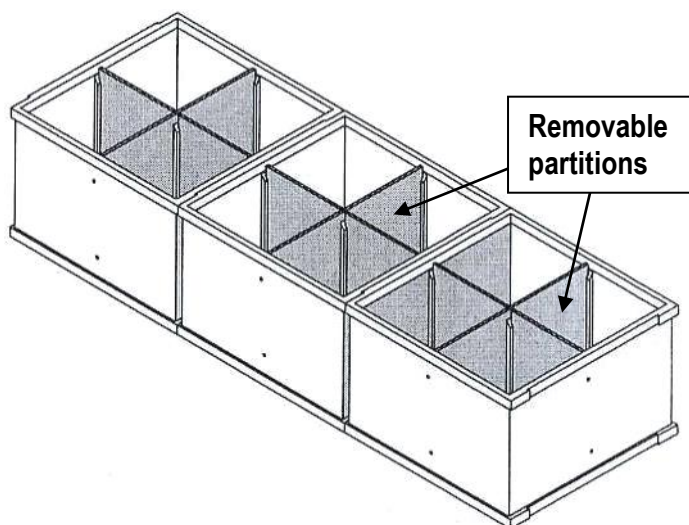

## 2.3 Controller

The controller front panel encompasses the COMMAND-DISPLAY MODULE, see paragraph 2.3.1 and the slot for the memory key, see paragraph 3.1-Data Portability.

The back panel, see paragraph 4.6.1, embodies the power module and the connection module, see also paragraph 4.6.

### 2.3.1 Command Display Module

This module of original design is located on the instrument front panel, and comprises a graphic display and a command keyboard.

The **multifunction** liquid-crystal **graphic-display** monitors the withdrawal latency to the nearest 0.1 second; **latency time** is the time elapsing from the moment the START key is activated to the moment the animal withdraws its paw.

The graphic display presents all available commands: the operator sets the experiment configuration via the command keyboard located on the right of the display.

### 2.3.2 Graphic Display

When the instrument is switched on, our logo with the two mice is displayed.

By depressing **F4 (ESC)**, you enter the user area.

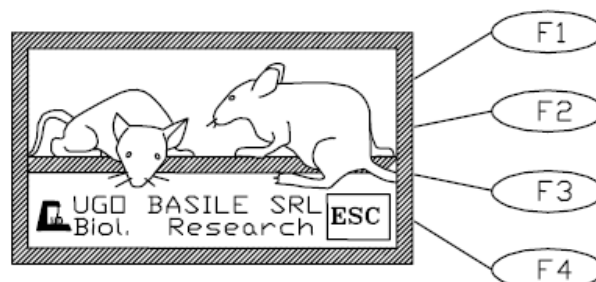

The four lines of the **top area** show:

- 1) the actual date
- 2) the actual time
- 3) the instrument serial number
- 4) the firmware version

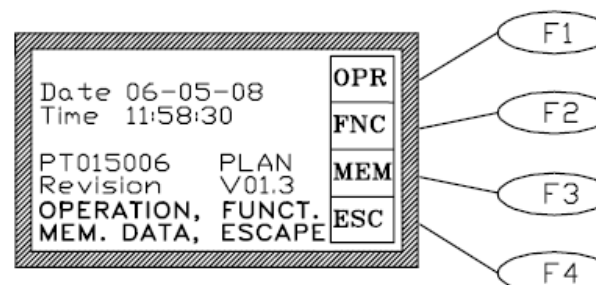

In all menus, the last two lines show the functions available by depressing the corresponding key on the right of the display.

The right portion of the display window shows the abbreviation of the key function, meaning:

- **OPR** Operation
- **FNC** Function
- **MEM** Memory
- **ESC** Escape

The **display contrast** can be modified, see paragraph 5.2-Display Contrast.

### 2.3.3 Keyboard

The keyboard, consisting of 4 soft push-button keys **F1**, **F2**, **F3** and **F4**, sets the experiment parameters, see paragraph 2.3.4 for reference.

### 2.3.4 Function Key Abbreviations

|            |                  |
|------------|------------------|
| <b>CAL</b> | Calibration      |
| <b>CFG</b> | Configuration    |
| <b>CLK</b> | Clock setting    |
| <b>DIS</b> | Display contrast |
| <b>DWN</b> | Decrement        |
| <b>ENT</b> | Enter            |
| <b>EPR</b> | External printer |
| <b>ESC</b> | Escape           |
| <b>FNC</b> | Function menu    |
| <b>FOR</b> | Force            |
| <b>FTR</b> | Feature menu     |

The **F4 key**, which has the function of **ESCAPE** key, enables the operator to leave a menu and go back to a previously selected one.

|             |                         |
|-------------|-------------------------|
| <b>MEM</b>  | Memory menu             |
| <b>MPR</b>  | MiniPrinter             |
| <b>MSK</b>  | Memory stick            |
| <b>NO</b>   | No                      |
| <b>NUL</b>  | Annulment               |
| <b>OK</b>   | Confirm                 |
| <b>OPR</b>  | Operation menu          |
| <b>OUT</b>  | Out                     |
| <b>PRN</b>  | Data printing selection |
| <b>RES</b>  | Data memory reset       |
| <b>RMP</b>  | Ramp                    |
| <b>STR</b>  | Start                   |
| <b>STP</b>  | Stop                    |
| <b>TEST</b> | Test                    |
| <b>UP</b>   | Increment               |
| <b>V.W</b>  | Data view               |
| <b>YES</b>  | Yes                     |
| <b>&gt;</b> | Shift to right          |
| <b>0g</b>   | Weight: 0 grams         |
| <b>5g</b>   | Weight: 5 grams         |
| <b>50g</b>  | Weight: 50 grams        |

### 3 DATA ACQUISITION & DATA PRINT-OUT

The Dynamic Plantar Aesthesiometer is a microprocessor controlled unit. The experimental data, stored in the 37450 internal memory and shown on its graphic display, can be directly exported to PC.

The USB connector type B connects directly into the PC USB port. This connector is located on the instrument back panel (see paragraph 4.6.1). The connection to PC is also possible via the serial port RS 232 C by the Delta 9-pin female connector (COM 1).

Communication is managed by the dedicated **CUB Package Cat. 52050-12**, supplied as standard.

The **CUB 52050** is a Windows<sup>®</sup> based Data Acquisition Software Package, which enables the research worker to route to the PC the data originated by all Ugo Basile instruments and store them into individual files, ready to be easily managed by most statistical analysis packages available on the market. See also paragraph 4.7.

**Ask for details!**

#### 3.1 Data Portability

Data portability is arranged via the **USB pen-drive (E-AU 041)** provided with the standard package. Via the USB slot provided on the front panel, all the experimental data of



one or more sessions can be easily uploaded on the pen-drive, see **B**, Figure 2, in paragraph 3.2

Programming the experiment layouts from a remote PC is also made easy by the use of the pen-drive.

### 3.2 Panel-Mount Printer 37000-145

The 37450 can be provided with a panel-mount printer, Cat. No. **37000-145**, to print the experimental data on its 58 mm wide paper, see (A) Figure 2.

The printer can be ordered together with the dynamic plantar aesthesiometer, or separately.

In fact, Its installation is extremely easy: you simply have to replace the top panel with a new panel incorporating the dedicated printer.



Figure 3 “Panel-Mount Printer and USB Pen-Drive”

**Ask for details!**

### 3.3 57145 MiniPrinter

In alternative to the 37000-145, the user may select the **MiniPrinter 57145**, a compact thermal array device, when planning to use the same to print-out data from more than one instrument (dynamic plantar or other)

The 57145 prints the print experimental data on its 58mm wide paper and does not require any mains cord: it drains the minimum power it needs from the instrument to which it is linked, via the data transmitting cable.

See paragraph 4.6 for connection to the Dynamic Plantar via the 10-pin cable provided with the Mini-Printer and paragraph 6.2 to enable the data print-out on the MiniPrinter.

For further details, please refer to Mini-Printer Instruction Manual.

## 4 INSTALLATION

### 4.1 Unpacking & Preliminary Check

Check the contents of the shipment for completeness, packing list to hand, and visually inspect the instrument as soon you take it out of the packaging. Use the supplied **Check List**.

If the instrument is damaged, inform the carrier immediately, notifying our company. If after having tested it, the Dynamic Plantar Aesthesiometer fails to meet rated performances, please contact our after sales service, see paragraph 9.5-Customer Support.



#### ***Protect the environment!***

Dispose of packaging properly, according to existing and applicable waste management rules and regulations.

### 4.2 Notes on the Instruction Manual

The Dynamic Plantar Aesthesiometer Instruction Manual included in the package (on the USB pen-drive) is necessary for the correct installation and operation of the instrument.

We recommend reading the manual with attention, as it is essential for the correct installation and operation of the instrument.

Please save the manual, ready to be consulted by the qualified personnel who use the instrument. Print it, only if necessary.

Our Instruction Manuals are available as free download on our web, see <http://www.ugobasile.com/support/documentation.html>.

For any additional information and/or assistance, you are welcome to contact our Service Department (see paragraph 9.5-Customer Support), specifying the serial number of your instrument.

### 4.3 Assembling the Equipment

#### 4.3.1 *Touch Stimulator*

The actuator vessel is provided with a black-plastic probe-guard to protect the probe-elevating mechanism during transport: remove it and put it in the accessory blister (Cat. 37400-321) for future use. Always reposition it during storage.

Within this same case, you will find 2 probes and an hex. (Allen) wrench. Position one of the two probes (the second is provided as spare) on the pushing rod (see figure 1 “Touch Stimulator”).



To install the probe, make sure to position it correctly on its pushing rod, by exerting a minimum force, until it has reached its most downward position, see Figure 4 “Positioning the Probe” for reference.

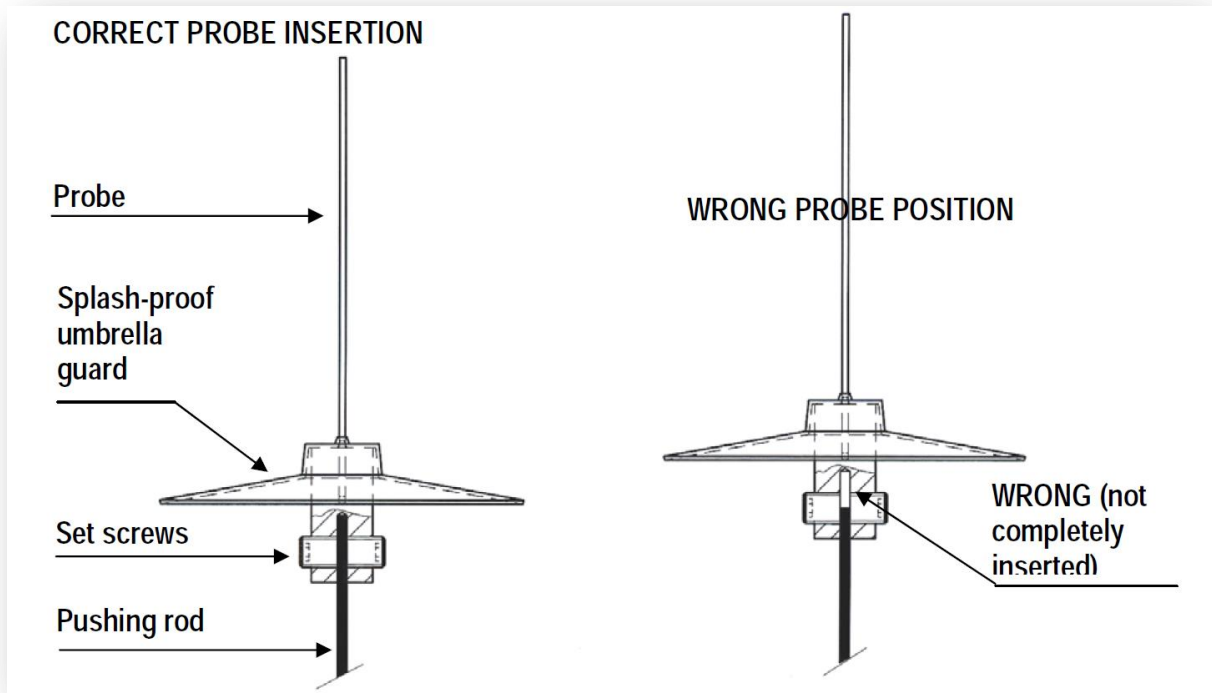

**Figure 4 “Positioning the Probe”**

Please avoid pressing too much or you risk jamming the pushing mechanism, which is the core of the instrument.

At this point, fasten the probe set screws via the hex. wrench provided.

#### **4.3.2 Assembling the Platform**

Assemble the Dynamic Plantar Aesthesiometer on a stable and flat bench or table surface.

Tighten the four supporting columns at the corners of the base platform, until their upper-right angle indentations are oriented to fit the angle blocks of the frame.

The frame is held in position by its own weight. See Figure 5 “Assembling the Platform”.

Lift the frame front bar 1-2 cm, to provide the clearance to insert the touch Stimulator. Make sure the vessel glides freely over all available surface.

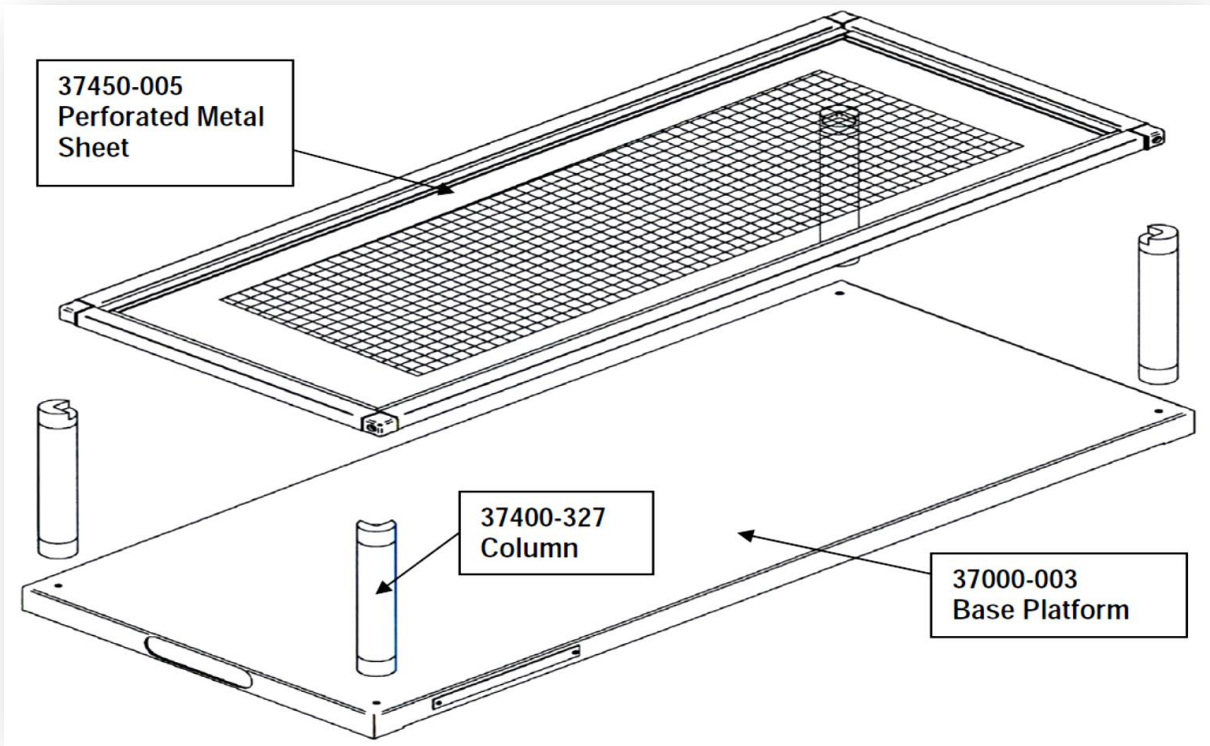

Figure 5 "Assembling the Platform"

There is a little clearance between the filament tip and the perforated metal sheet; the probe, when not activated, should never touch the metal surface, see Figure 4 "Positioning the Touch Stimulator".

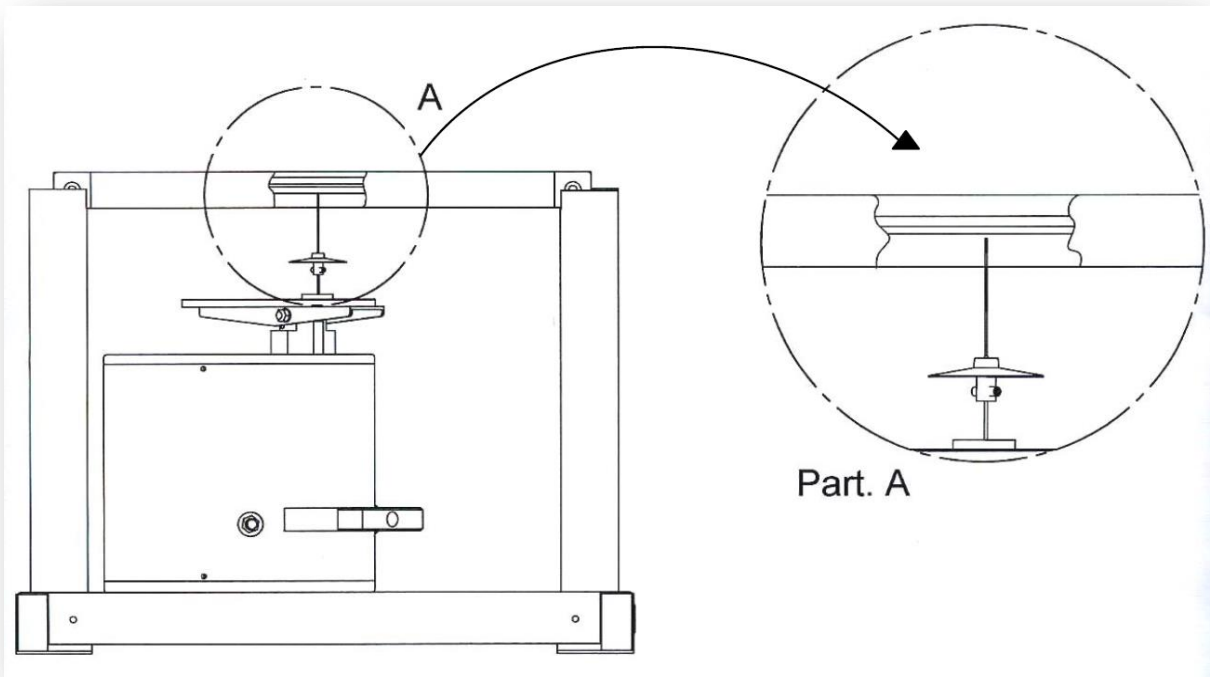

Figure 6 "Positioning the Touch Stimulator"



**Do not drag the Touch Stimulator out from underneath the perforated sheet. Rather remove the perforated sheet first, lest you damage the filament or pushing mechanism.**

#### 4.3.3 *Assembling & Positioning the Enclosure*

Assemble the animal enclosure, combining the 3 animal cages, as clearly indicated in the assembly instructions included in each box. Obtain the number of spaces you need (up to 4 per each cage), by the grey partitions provided, see also paragraph 2.2.1.

Use the four spacers provided, leaving them in place during test, to make sure the enclosure is correctly positioned and held in place. This will enable the filament of the touch stimulator to scan the entire floor of the enclosure.

Position the enclosure over the framed perforated metal sheet.

#### 4.3.4 *How to Handle the Dynamic Plantar Aesthesiometer*

The Dynamic Plantar Aesthesiometer is a relatively bulky and heavy instrument, with fragile parts, and it is recommended that once it is assembled, you do not attempt to lift or move the combined unit.

In particular, do not incline the base!

### 4.4 Environment

Avoid direct illumination of the enclosure compartments, e.g., from a table lamp; this will definitely upset the animals which dislike full light, not to speak of the risk to raise their body temperature, also taking into account body heat, confined space, good thermal insulation of Perspex, etc..

Moreover, intense light will be scattered by the perforated metal sheet and reflected by the angled mirror, leading to **poor visibility of the probe**. A low-wattage table lamp is appropriate for illuminating laterally. The light scattered by the probe will generally improve its visibility, without causing glare.



We recommend **absorbing with cotton wool any occasional large emission of urine** during familiarization or test time. Even though the filament is provided with its tiny umbrella, small quantities of urine may by-pass it, enter the upward-pushing mechanism, and - in the long run – jam it.

In order to avoid such unwanted result, **avoid keeping the stimulation vessel below the animal during familiarization**, positioning it below the animal only when ready to start the test.

## 4.5 Before Applying Power

Consider the Power Module on the back side of the Control Unit, which includes (from left to right):

- the inlet connector of the mains cord
- the mains switch
- the fuse holder

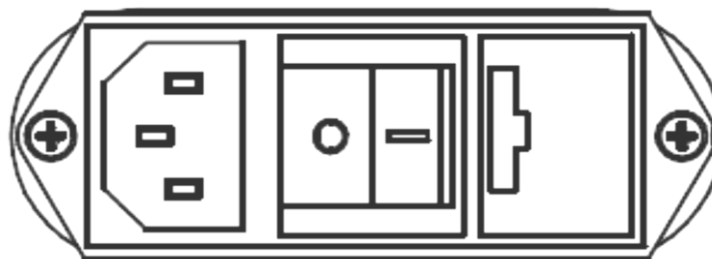

*Figure 7 “Power Module”*

### 4.5.1 Fuse Holder

The instrument is provided with 2 fuses, on both neutral and live. To replace fuses, if necessary, pull out the fuse slide, see paragraph 9.1-Electrical.

It is recommended to use fast-blow fuses type F2A; make sure that only fuses with the required rated current and of the specified types are used for replacement.

The use of repaired fuses and the short circuiting of the fuse holders must be avoided.

### 4.5.2 Main Switch

This two-pole toggle switch, which complies with international safety standards, provides a visual cue, to signal the:

- **OFF** position by **○**
- **ON** position by **I**

### 4.5.3 Mains Cord

It is a standard cable, Cat. # E-WP008, see paragraph 11-ORDERING INFORMATION. Make sure your power outtake is provided with a reliable ground connection.

## 4.6 Connections

Connect the mains cord to a power outtake, provided with a reliable earth connection, protected by a differential earth-leakage switch (CGFI) that breaks at the threshold of 0.03A, within a max. acceptable delay of 1s. The maximum breaking compliance required by the CGFI is 10kA at rated current is 6A.

#### 4.6.1 Back Panel

Beside the mains module, the back panel embodies a connection module, see figure below:

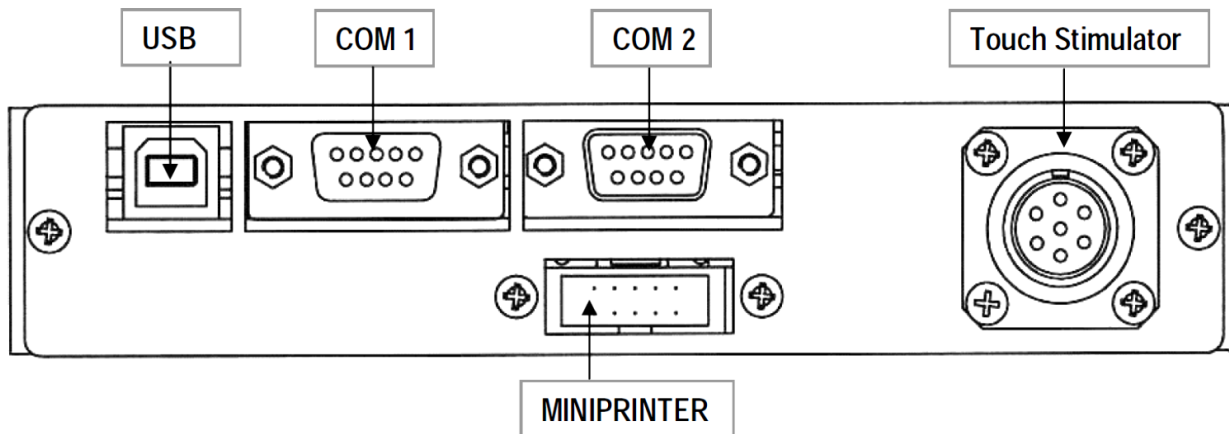

**Figure 8 “Back Panel”**

The connection module encompasses, from left to right:

- USB** this USB type B connector for linking the 37450 to the USB port of the PC
- COM1** a delta 9-pin female connector for connection to the serial port RS232C of the PC
- COM2** a second delta 9-pin connector (male) for connection to an external serial printer
- MINI PRINTER** a 20-pin connector to the Mini Printer Cat. 57145, see also (see paragraphs 3.3 and 11.3)
- TO TOUCH STIMULATOR** a 7-pin circular connector to link the Touch Stimulator 37400-002 to the Controller 37450-001. This cable connector features a push-pull latch. Pull out the knurled ring to remove the connector.

Mismatching the connection is prevented by the different individual pin arrangement.

#### 4.7 Installation of CUB software

The CUB software is contained in the USB pen-drive provided with the instrument. Install it on your PC.

At the first installation, a code will be generated: send the code to [registra-tion@ugobasile.com](mailto:registra-tion@ugobasile.com) to receive an **activation key**.

From the installation, you have 30 days to enter the activation key; when the 30 days trial period expires, it will not be possible to activate the software and it will be necessary to

uninstall and install it again (ask for instruction at our Customer Support, see paragraph 9.5).

## 4.8 Intended Use

The Dynamic Plantar Aesthesiometer is intended for investigation use on laboratory animals only.

## 4.9 General Safety Instructions

The following guidelines must be followed to ensure safe operation.

- ! **DO NOT** attempt to open or perform any service work
- ! **DO NOT** connect up human subjects



## 4.10 Additional Safety Consideration

- a. Place your Dynamic Plantar Aesthesiometer on a flat surface;
- b. Do not obstruct free and comfortable access to the power module;
- c. Use original accessories and spare parts only, see also paragraph 11-ORDERING INFORMATION
- d. Immediately disconnect and replace a damaged mains cable;
- e. Do not operate the instrument in hazardous environments or outside prescribed environmental limitations (i.e. +18C°/+24C°, 60% relative humidity, non-condensing);
- f. Do not spray any liquid on the connectors.

**UGO BASILE DOES NOT ACCEPT ANY RESPONSIBILITY FOR PROBLEMS OR HARM CAUSED TO THINGS OR PERSONS, ARISING FROM:**

- incorrect electrical supply;
- incorrect installation procedure;
- incorrect or improper use or, in any case, not in accordance with the purpose for which the instrument has been designed and the warnings stated in the instruction manual supplied with the instrument;
- replacement of original components, accessories or parts with others not approved by the manufacturer;
- servicing carried out by unauthorized personnel

## 5 OPERATION

### 5.1 Switching On



Before switching on, make sure the probe-guard has been removed and the probe is correctly positioned on its pushing rod.

Switch on the 37450; the software takes some seconds to perform a complete checking of the electronic circuit. During the checking, the display shows the mice logo. By depressing ESC, the display shows the software version which is actually installed, e.g., "V01.3", see paragraph 2.3.2.

The software version is necessary in case of communication with our laboratory for operational or servicing problems.

In case one of the captions **MEMORY LOSS!!** appears on the display, please refer to paragraph 9.1.1-Battery Replacement.

### 5.2 Display Contrast

To modify the display contrast, depress the **F2 (FNC)** key from the Main Menu, then the **F3 (DIS)** key. The display shows:

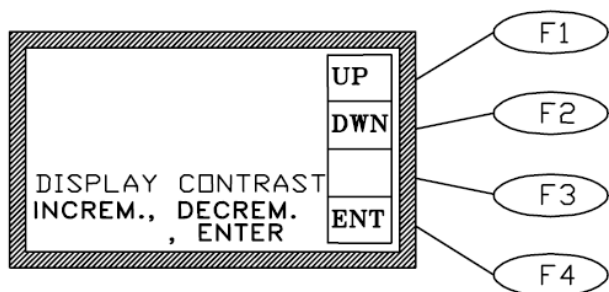

Keep the arrow keys **F1 (UP)** or **F2 (DWN)** depressed until you reach the desired display contrast.

The readability of the liquid crystal display depends on the angle of view: select the ideal contrast according to the height of the table, the operator's distance and so on.

### 5.3 Setting Force and Rate Application

Before carrying out the test on the animal, set the Force and Rate.

Depress the **F1 key (OPR)** from the main menu. The display will show three different options:

- F1 (TST)** test
- F2 (CFG)** configuration file
- F3 (CAL)** calibration procedure (see paragraph 8)

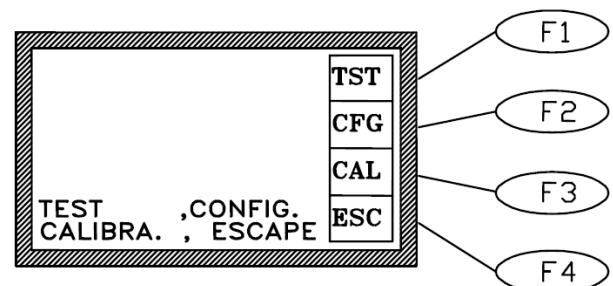



To start the experiment trial, depress the **F1 (TST)**, followed by the **F1 (STR)** key.

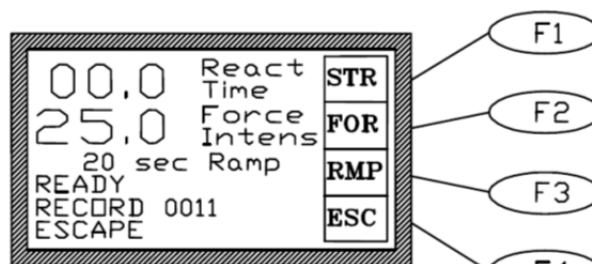

At this point, an automatic procedure will start, enabling a light positioning of the probe under the animal paw.

If the probe does not find the aimed area to be stimulated (the paw) the following display will appear, indicating "POSITION ERROR".

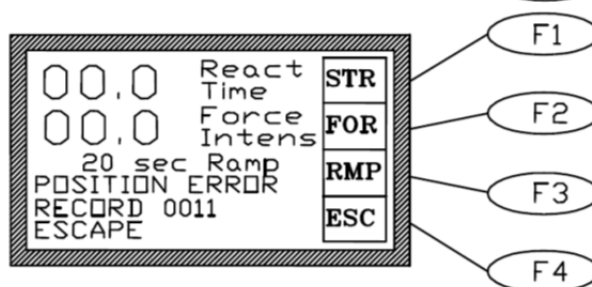

Depress **F2 (FOR)** to set the force in grams, by acting on the **F1 (UP)** or **F2 (DWN)** keys. The force increases in 0.1g steps, from 0.5 to 5g and in 0.5g steps, from 5 to 50g.

The set value is monitored by the figure marked as "FORCE INTENS" (second level of the display).

Depress **F3 (RMP)** to set the desired rate (ramp), by acting on the **F1 (UP)** or **F2 (DWN)** keys.

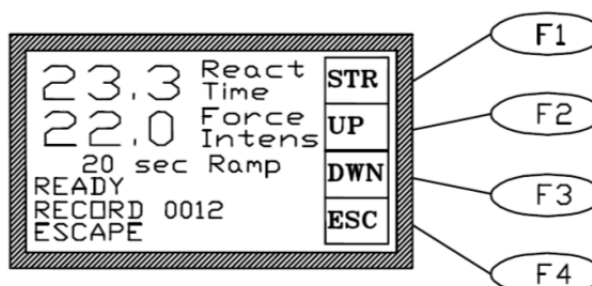

The set value is monitored by the figure marked as "sec Ramp." (third level of the display).

Keep in mind that if the force increasing rate (ramp) is set to 0, the preset force is immediately reached.

## 5.4 Carrying out the Test on the Animal

Place the animals in their compartments positioned on the metal mesh surface and observe them! After a short period of time, the rodents will cease exploratory behaviour and they stay quietly in a resting position, with occasional bouts of grooming.



**Avoid keeping the stimulation vessel below the animal during familiarization**, positioning it below the animal only when ready to start the test, see also paragraph 4.4.

After the acclimation period, the touch stimulator placed under the perforated platform (see picture) is positioned by the operator directly beneath the paw; The target for the probe is typically the plantar surface of the paw and, more preferably, the hind paw, since the animal tends to rest thereon.

With the aid of the adjustable angled mirror, see also paragraphs 0 & 4.3.2, place the Stimulator beneath the animal paw to position the probe directly below the target area.

By depressing the START key on either side of the vessel, or **F1 (STR)** on the front panel, the following automatic sequence is started:

- the electrodynamic actuator lifts the probe;
- the probe touches the plantar surface and begins to exert an upward force below the threshold of feeling;
- the force increases (at the preset rate of application), until the animal removes its paw or until the point at which greatest preset force is met.
- when the animal withdraws its paw, the touch stimulator stops exerting the upward force, the filament goes back to the original position, and the reaction time counter stops, automatically recording the withdrawal latency to the nearest 0.1s, as well as the actual force at which the animal reacted.

The datum shown on the display can be printed on the Mini-Printer or routed to the PC, see paragraph 6-OPERATING WITH MINI PRINTER AND PC.

In case the animal does not withdraw its paw when the preset force intensity is reached, the actuator goes on exerting the same force until the operator depresses the START key again; in this case, the datum is not recorded.

The experiment schedule is left to the requirements and personal preferences of the researcher. For example, if the force increasing rate (ramp is set to 0), the preset force is immediately reached.

## 5.5 Durham Holders for Orofacial Stimulation

The Durham Animal Holders are the newest accessory for use with the Dynamic Plantar Aesthesiometer and Plantar Test, manufactured by Ugo Basile.

These animal holders extend the scope of the infrared (IR) thermal stimulus of the Plantar Test to trigeminal stimulation. In fact, this new invention allows the application of the same stimulus to the region innervated by the trigeminal nerve.

The 37100 includes two holders, form-moulded for testing specific size ranges; the two sizes have been optimized for young adult rats and for bigger rats.

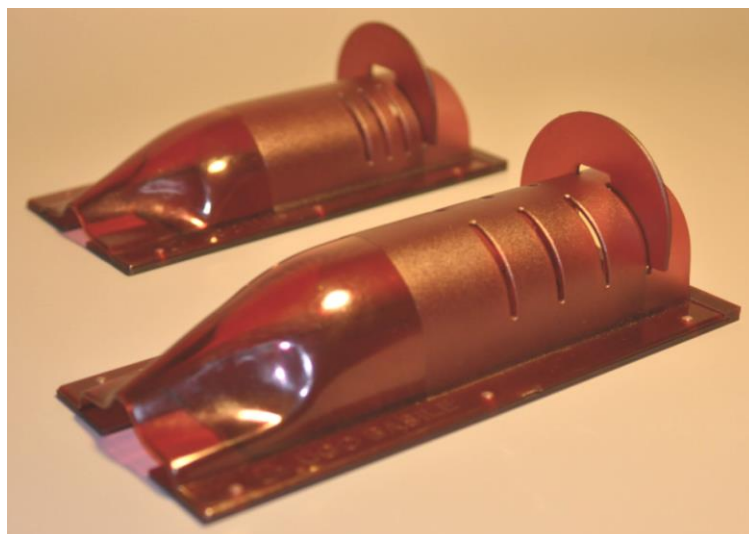

See ordering information, paragraph 11.2-Optional and bibliography, paragraph 12.2.

## 5.6 How to Set a Customized Experimental Configuration

This function enables the operator to personalize the basic datum by adding, in sequence:

- sequence number (see 5.6.1)
- experiment number (see 5.6.2)
- animal gender (see 5.6.3)

From the main menu, depress the **F2 (FNC)** key, followed by the **F1 (OUT)** key. Depress again the key **F2 (FTR)**; the display shows the first setting, the sequence number.

All the available selections for each additional information are displayed in a loop. Scan them by the **F1 (UP)** or **F2 (DWN)** keys, select the suitable one and confirm the selection by depressing the **F4 (OK)** key, or avoid one or more features by depressing the **F3 (NUL)** key.

The selected features will be maintained even if the instrument is turned off.

To erase one or more features previously set, simply enter this software level, highlight the concerned feature and depress the **F3 (NUL)** key.

After entering the last feature (M or F), the software goes automatically back to the main menu.

### 5.6.1 Sequence Number

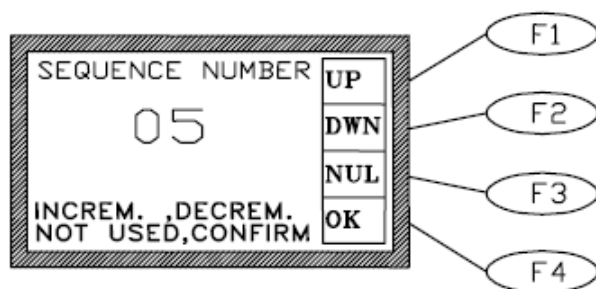

The first additional information to be defined is the sequence number. This section is highlighted as soon as the **F2 (FTR)** key is depressed.

Use the **F1 (UP)** or **F2 (DWN)** key to set the desired sequence number from 01 to 99 and confirm it by depressing the **F4 (OK)** key.

The sequence number will automatically increase by one figure at any subsequent measurement. It trips once a datum has been acquired and recorded, indicating the fresh sequence number ready for the next measurement.

If a sequence number is not necessary, depress the **F3 (NUL)** key.



#### **IMPORTANT:**

When a fresh experimental session is begun, the sequence number can be carried on from the number reached at the end of the previous trial or a new number can be entered, following the instructions outlined above, for example starting from 01.

### 5.6.2 Experiment Number

As soon the **F4 (OK)** or **F3 (NUL)** keys are depressed, followed by the **F4** key again, the second option is highlighted.

The experiment number, from 1 to 9, can now be selected via the **F1 (UP)** or **F2 (DWN)** key and confirmed via the **F4 (OK)** key.

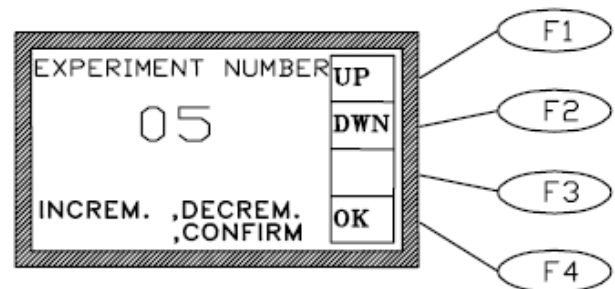

#### IMPORTANT:

The experiment number is also used to label the data export file on the USB pen-drive (for example: [DATA01.txt](#), where the experiment number is 1, [DATA02.txt](#), where the experiment number is 2, etc.

### 5.6.3 Animal Gender

After the experiment number, it is possible to define the gender of the animal to be processed: **MALE/FEMALE**.

Select it by depressing the **F1 (UP)** or **F2 (DWN)** key and confirm it via the **F4 (OK)** key; avoid the gender selection by depressing the **F3**.

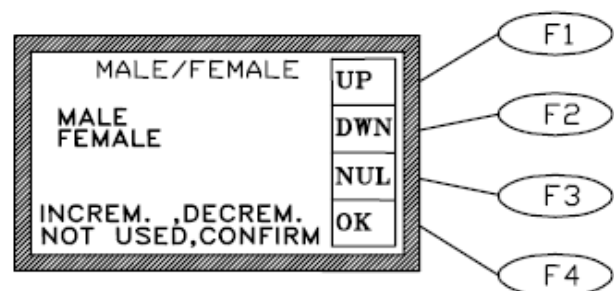

## 5.7 Configuration File

Up to 6 different experiments can be configured, following the instructions outlined in previous paragraphs, saved in the memory key, ready to be recalled to the PC and/or to the instrument.

The involved parameters are:

- Force
- Ramp
- Experiment Number
- Gender
- Sequence Number
- MiniPrinter

### 5.7.1 From the Memory Key to the Instrument

With the memory key inserted in its slot on the front panel, depress **F1 (OPR)**, **F2 (SET)** and **F3 (CFG)**.

The “**READING CONFIGURATION**” window appears; after some seconds, select the desired configuration by the **F1 (UP)** or **F2 (DWN)** key, then confirm the selection by the **F3 (OK)** key.

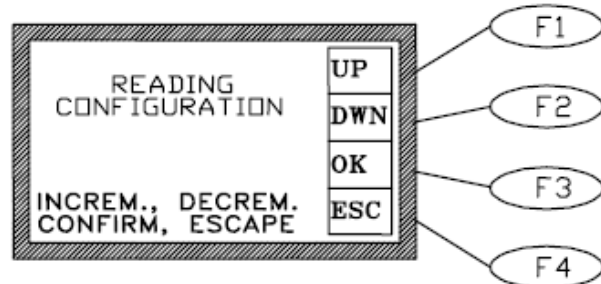

Under the configuration name, for example “**CONFIG01.CFG**”, the related date appears (save date).

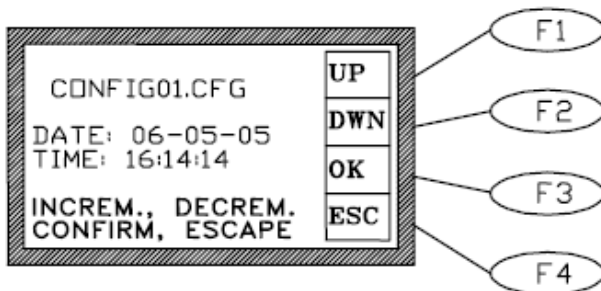

If the configuration is not present, the caption “**NOT PRESENT**” appears instead of the date.

### 5.7.2 Uploading

If the configuration is present, it can be uploaded and the instrument parameters can be changed, by depressing **F1 (CHG)**.

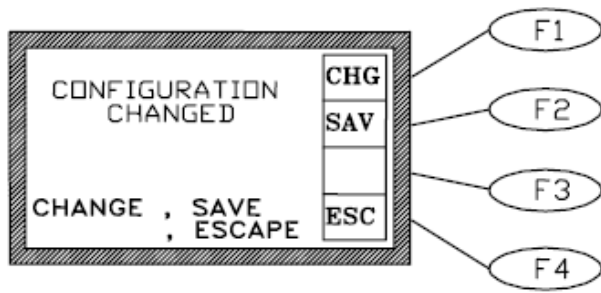
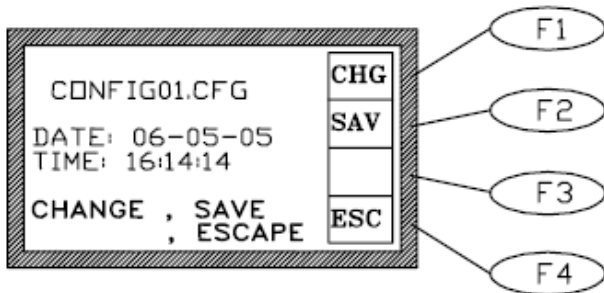

The caption “**CONFIGURATION CHANGED**” confirms the change.

### 5.7.3 Downloading

If the configuration is present, the user can overwrite it with the current instrument parameters by depressing **F2 (SAV)** and **F1 (YES)** or create a new configuration file, by depressing only and **F2 (SAV)**.

The caption “**CONFIGURATION SAVED**” confirms the overwriting.

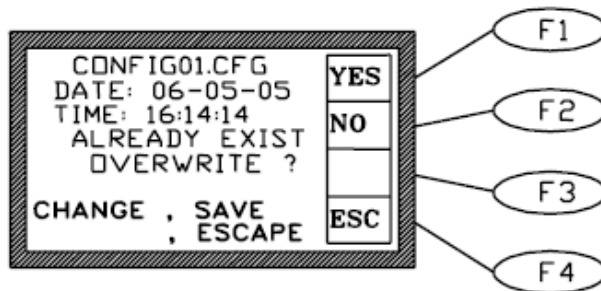



### 5.7.4 From USB-Key to PC

With the USB-key inserted in its slot on the PC, it is possible to import or export a configuration to/from the memory key.

From the CUB software, select **DATA/MEMSTICK > LOAD CONFIG** or **SAVE CONFIG**.

### 5.7.5 From PC to Instrument

It is possible to send or read the current configuration directly from/to the instrument.

From the CUB software, select **DATA/MEMSTICK > READ CONFIG** or **WRITE CONFIG**.

## 6 OPERATING WITH MINI PRINTER AND PC

### 6.1 How to set the Data output to PC

The experimental data are saved in the instrument internal memory. During the experimental trial, the data can also be routed to the PC for real-time or remote communication.

First of all, install the CUB Software, see paragraph 4.7. Then connect the cables as outlined in paragraph 4.6-Connections.

Open the CUB Program and select '**FILE-CONFIGURATION**' and the type of connection, serial or USB (Help). It is not necessary to take any further action: the data are always routed to the PC (even when the PC is not connected).

USB and serial communication between the Dynamic Plantar Aesthesiometer and the PC is managed by the Ugo Basile CUB (or Win-DAS) software, see paragraph 3 and software manual.

### 6.2 How to set the Data output to MiniPrinter

The experimental data are saved in the instrument internal memory. During the experimental trial, the data can also be printed-out in real time via the optional **57145 Thermal MiniPrinter**, see paragraph 11.3.

In case of operation in conjunction with the Mini-Printer the operator has to select the data output path menu.

From the main menu, depress **F2 (FNC)** key, followed by the **F1 (OUT)** key. The display shows:

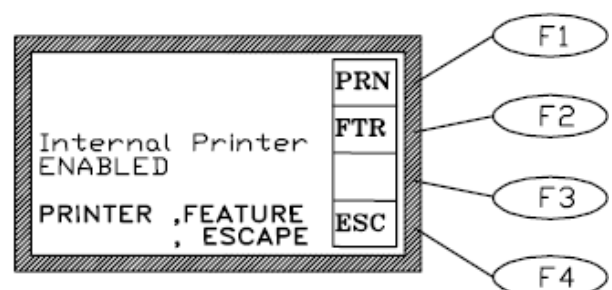

Depress now the **F1 (PRN)** key, the display shows:

**Internal Printer  
ENABLED (or DISABLED)**

Each time the **F1 (PRN)** is depressed, the printer status changes (from **ENABLED** to **DISABLED** or from **DISABLED** to **ENABLED**).

### 6.3 Datum Format

When routed to the PC via the CUB (or Win-DAS) Data Acquisition Software (see the related manual), the data can be monitored on the “**TEST MANAGER**” window, which can be accessed to by depressing the “**TEST**” botton.

The following is a sample of the datum, as it appears on the PC:

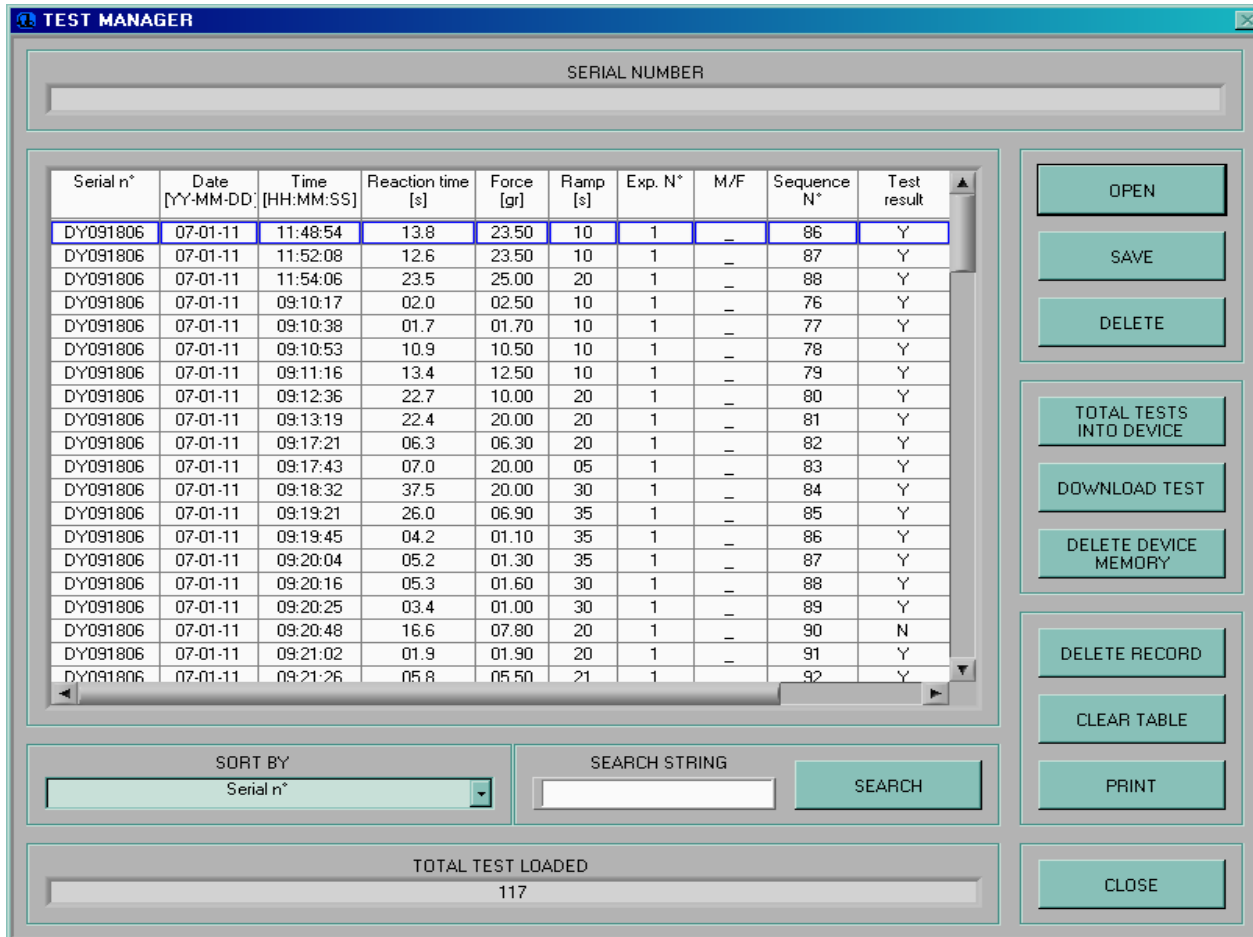

The screenshot shows the TEST MANAGER window with a table of test data. The table has the following columns: Serial n°, Date [YY-MM-DD], Time [HH:MM:SS], Reaction time [s], Force [gr], Ramp [s], Exp. N°, M/F, Sequence N°, and Test result. The data rows show various test parameters for multiple trials.

| Serial n° | Date [YY-MM-DD] | Time [HH:MM:SS] | Reaction time [s] | Force [gr] | Ramp [s] | Exp. N° | M/F | Sequence N° | Test result |
|-----------|-----------------|-----------------|-------------------|------------|----------|---------|-----|-------------|-------------|
| DY091806  | 07-01-11        | 11:48:54        | 13.8              | 23.50      | 10       | 1       | -   | 86          | Y           |
| DY091806  | 07-01-11        | 11:52:08        | 12.6              | 23.50      | 10       | 1       | -   | 87          | Y           |
| DY091806  | 07-01-11        | 11:54:06        | 23.5              | 25.00      | 20       | 1       | -   | 88          | Y           |
| DY091806  | 07-01-11        | 09:10:17        | 02.0              | 02.50      | 10       | 1       | -   | 76          | Y           |
| DY091806  | 07-01-11        | 09:10:38        | 01.7              | 01.70      | 10       | 1       | -   | 77          | Y           |
| DY091806  | 07-01-11        | 09:10:53        | 10.9              | 10.50      | 10       | 1       | -   | 78          | Y           |
| DY091806  | 07-01-11        | 09:11:16        | 13.4              | 12.50      | 10       | 1       | -   | 79          | Y           |
| DY091806  | 07-01-11        | 09:12:36        | 22.7              | 10.00      | 20       | 1       | -   | 80          | Y           |
| DY091806  | 07-01-11        | 09:13:19        | 22.4              | 20.00      | 20       | 1       | -   | 81          | Y           |
| DY091806  | 07-01-11        | 09:17:21        | 06.3              | 06.30      | 20       | 1       | -   | 82          | Y           |
| DY091806  | 07-01-11        | 09:17:43        | 07.0              | 20.00      | 05       | 1       | -   | 83          | Y           |
| DY091806  | 07-01-11        | 09:18:32        | 37.5              | 20.00      | 30       | 1       | -   | 84          | Y           |
| DY091806  | 07-01-11        | 09:19:21        | 26.0              | 06.90      | 35       | 1       | -   | 85          | Y           |
| DY091806  | 07-01-11        | 09:19:45        | 04.2              | 01.10      | 35       | 1       | -   | 86          | Y           |
| DY091806  | 07-01-11        | 09:20:04        | 05.2              | 01.30      | 35       | 1       | -   | 87          | Y           |
| DY091806  | 07-01-11        | 09:20:16        | 05.3              | 01.60      | 30       | 1       | -   | 88          | Y           |
| DY091806  | 07-01-11        | 09:20:25        | 03.4              | 01.00      | 30       | 1       | -   | 89          | Y           |
| DY091806  | 07-01-11        | 09:20:48        | 16.6              | 07.80      | 20       | 1       | -   | 90          | N           |
| DY091806  | 07-01-11        | 09:21:02        | 01.9              | 01.90      | 20       | 1       | -   | 91          | Y           |
| DY091806  | 07-01-11        | 09:21:26        | 05.8              | 05.50      | 21       | 1       | -   | 92          | Y           |

Below the table, there is a 'SORT BY' dropdown menu set to 'Serial n°', a 'SEARCH STRING' input field, and a 'SEARCH' button. At the bottom, there is a 'TOTAL TEST LOADED' field showing '117' and a 'CLOSE' button. On the right side of the window, there are several control buttons: OPEN, SAVE, DELETE, TOTAL TESTS INTO DEVICE, DOWNLOAD TEST, DELETE DEVICE MEMORY, DELETE RECORD, CLEAR TABLE, PRINT, and CLOSE.

**Figure 9 “Test Manager Window”**

The first column shows the **Serial N°**, beginning with the abbreviation DY which stays for Dynamic Plantar Aesthesiometer.

Second and third column show the date and time respectively.



The following columns show the datum proper, in the following format, see the first line, in the example above:-

- 13.8** = Reaction time (in seconds)
- 23.50** = Force (in grams)
- 10** = Ramp (in seconds)
- 1** = Experiment number
- = Animal gender
- 86** = Sequence number
- Y** = Test result :
  - Y** = the test has been completed properly
  - N** = the test has been aborted by the operator
  - T** = the reaction time of the animal has been longer than 90 s
  - A** = the reaction time of the animal has been shorter than 0.3 s

## 6.4 Quick setting of the 37370 Dynamic Plantar Aesthesiometer

This Instruction Manual extensively explains how to take advantage of all the features offered by this microprocessor controlled unit.

The following table summarizes them; however, we recommend you to browse the complete manual to go deep into details.

Each sequence of commands is described starting from the **MAIN MENU**.

| <b>Command Description</b>   | <b>Command Sequence</b>  | <b>Paragraph reference</b> |
|--|--|----------------------------|
| Set <b>Printer ON</b>  | <b>(FNC) - (OUT) - (PRN)</b>   | 6.2                        |
| Print <b>DATA</b> previously saved in the 37450 memory                     | <b>(MEM) - (OUT) - (MPR)</b>   | 7                          |
| Send <b>DATA</b> previously saved in the 37450 memory <b>to memory key</b> | <b>(MEM) - (OUT) - (MSK)</b>   | 7                          |
| Send <b>DATA</b> previously saved in the 37450 memory <b>to PC</b>         | <u>from <b>CUB</b> program:</u><br>TEST > Download Test  |                            |
| Set <b>TIME &amp; DATE</b>   | <b>(FNC) - (CLK) - (UP) / (DWN)</b> to set the correct value - <b>(&gt;) - (ENT)</b>             | 7.2                        |
| Set <b>DISPLAY CONTRAST</b>  | <b>(FNC) - (DIS) - (UP) / (DWN)</b> until the desired contrast is reached - <b>(ENT) - (ESC)</b> | 5.2                        |

## 7 MEMORY MANAGEMENT

Each datum point, no matter whether printed or sent to the PC, is saved in the memory (which can store about 300 measures, including the datum proper and the date/time indication).

By depressing the **F3 (MEM)** key from the main menu, the **MEMORY** Menu can be reached.

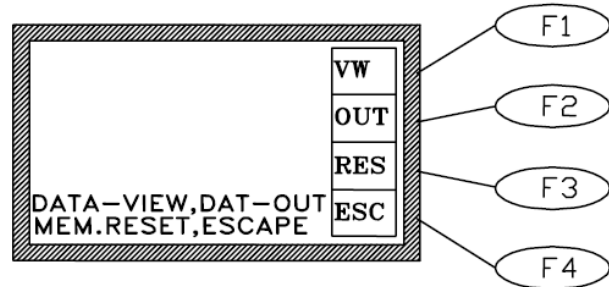

The **F1 (VW)** key enables the operator to visualize on the data stored in the memory, each datum complete with acquisition Date & Time. The top datum, is the last datum which has been memorized.

Use the vertical-arrow keys **F1 (UP)** or **F2 (DWN)** to scan the data; by momentarily depressing the key, the displayed datum will increase (or decrease) of one measurement.

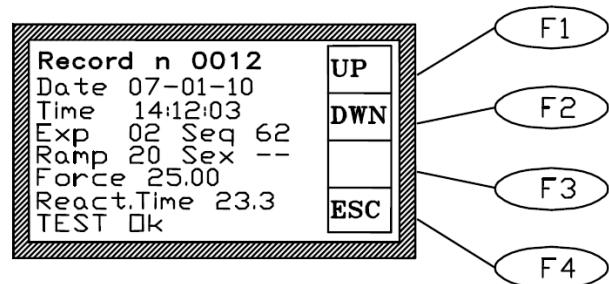

Keeping these keys depressed longer will scan the data.

As usual the **F4 (ESC)** recalls the previous menu software.

From the **MEMORY** Menu, the **F2 (OUT)** key enables the researcher to export the data stored in the memory to the Memory Key or to print them on the Mini-Printer.

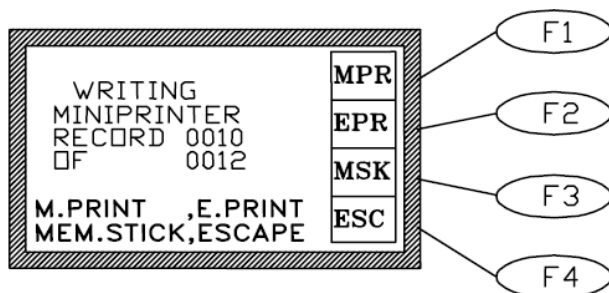
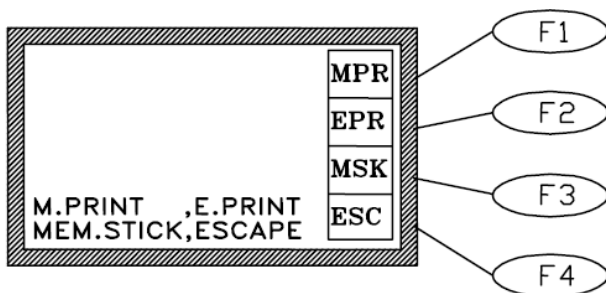

You can now select the data output path, see paragraph 6, by depressing:

**F2 (EPR)** to select an External Printer (\*) via COM2, located on the back panel, see paragraph 4.6.1.

(\*) *customer printer connected in serial on COM2 at 9600 baud-rate*

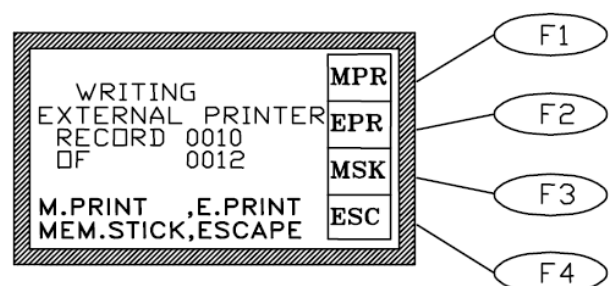

**F3 (MSK)** to select the **Memory Key**, inserted in its slot on the front panel.

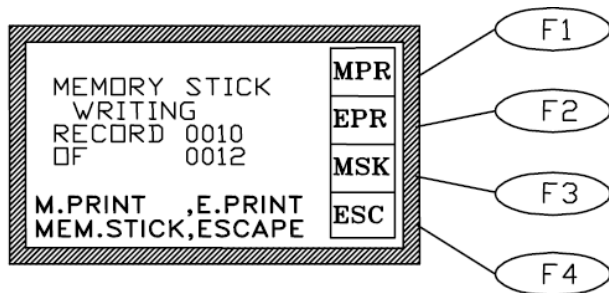

To interrupt the print-out response of the stored data, depress the **F4 (ESC)** key for one second at least.



Before starting a new experimental session, we suggest checking the memory which may contain some data of the previous trial.

If it is the case, enter the proper software level and **RESET** the memory, see paragraph 7.1

## 7.1 Memory Reset

From the Memory menu, the F3 key (RES) enables the operator to reset the data stored in the memory.

This command can be useful, for instance, before starting a new experimental session, if the operators prefers to cancel the data saved from previous experiments.

Answer **(YES)** (**F3** key) or **(NO)** (**F4** key) to the question: **“ARE YOU SURE?”**.

The Memory menu automatically appears also when the memory is fully loaded, which means it has reached its maximum capability of about 300 measures.

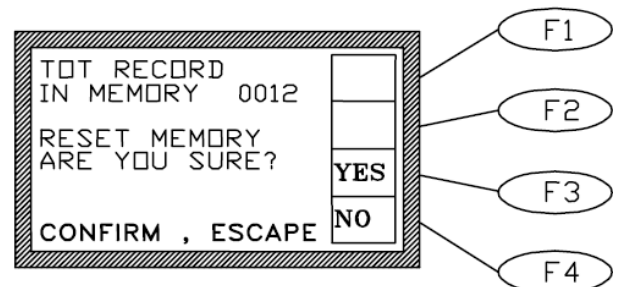

### 7.1.1 “Memory Full” Message

If the **“MEMORY FULL”** message appears during acquisition, the operator has three options:

- if not interested in the data saved in the memory, simply depress the **F4 (ESC)** key, followed by the **F3 (RES)** and confirm the reset by answering **F3 (YES)** to the question **“ARE YOU SURE?”**, see paragraph 7.1.

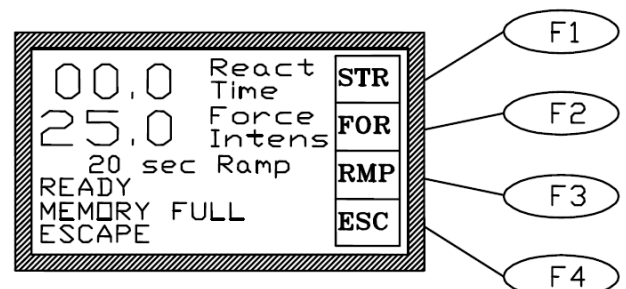

- When **the data** previously saved in the memory are **to not to be cancelled**, the researcher may print and/or send them to the memory key or PC as previously explained (see paragraph 7-MEMORY MANAGEMENT).

- There is also the possibility to **ignore the indication of “MEMORY FULL”** and go on with the experiment. The data acquired onwards will not be saved.

Consider that, in this case, the memory remains fully loaded and the display reminds it by showing the message “MEMORY FULL” at each measure.

## 7.2 Setting Time & Date

To set time and date, from the Main menu depress the **F2 (FNC)** key, followed again by the **F2 (CLK)** key.

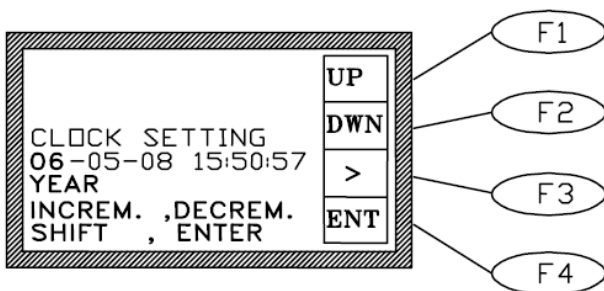

Use the **F3** horizontal arrow key to highlight the parameter to be modified.

Now use the **F1 (UP)** or **F2 (DWN)** keys to set the correct value; a momentarily action on the keys will increase or decrease the numerical value of one step: depress the keys longer for faster selection.

Depress the **F2 (ENT)** key to confirm the selection.

## 8 CALIBRATION

From the MAIN menu, depress the **F3 (CAL)** key.

### Calibration Step 1:

First, make sure the probe is mounted on its pushing rod.

Then, **without any weight on the probe**, depress the **F1 (0g)** key to perform the zeroing.

An automatic procedure takes place: the display shows in sequence: “WAITING POSITION”, “DE-CREASING FORCE”.

Finally the following display will appear:-

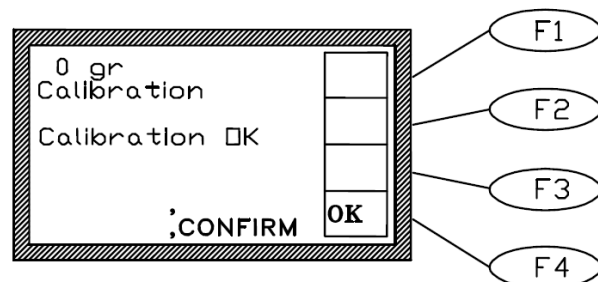

Confirm the calibration by depressing the **F4 (OK)** key.

### Calibration Step 2:

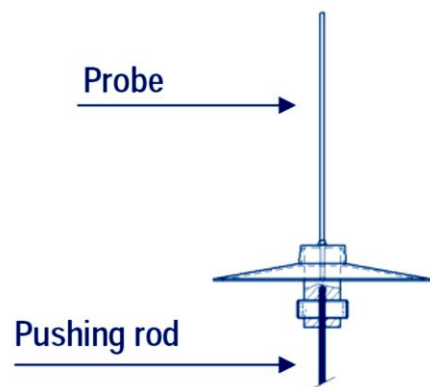

Now **remove the probe** and **run the calibration with an additional weight.**

Selected the calibration weight between the two available:

- the 5 grams calibration weight (right, in the picture) for trials which involve forces from 0.5 to 5 grams
- the 50 grams calibration weight (left, in the picture) for trials which involve forces from 5 to 50 grams

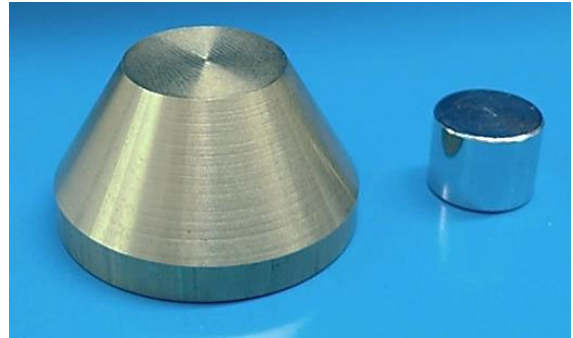

You can find both weights in the accessory case. If you select the 5g weight, start the calibration by depressing the **F2 (5g)** key. At the end of the procedure, confirm by the **F4 (OK)** key.

If the 50 g weight is involved, start the calibration by depressing the **F3 (50g)** key and confirm by depressing by the **F4 (OK)** key.

## 9 MAINTENANCE

While any service of the instrument ought to be carried out by Ugo Basile personnel or by qualified personnel authorized by UGO BASILE organization, this section of the instruction manuals describes normal maintenance procedures which can be carried out at your facility.



**UNPLUG THE MAINS CORD BEFORE CARRYING OUT ANY MAINTENANCE JOB!**

### 9.1 Electrical

To inspect and/or replace the fuses, disconnect the mains cable first! Insert a miniature screwdriver in the slot indentation, see paragraph 4.5.1, and snap out the slide which houses the fuses.

The Dynamic Plantar Aesthesiometer universal mains input accepts any voltage from 85 to 264 Volt AC., for which we recommend the use of 2A fast-blow fuses (type F2A).

Snap in the fuse slide: the mechanical “click” ensures that it is locked.

#### 9.1.1 Battery Replacement

The Dynamic Plantar Aesthesiometer memory is supported by a battery snap type **M4T32-BR12SH1** of ST.



The rated battery endurance is 10 years, therefore replacing the batteries is not a frequent task.

When the batteries are exhausted, the display shows the caption **"MEMORY LOSS!!"**.

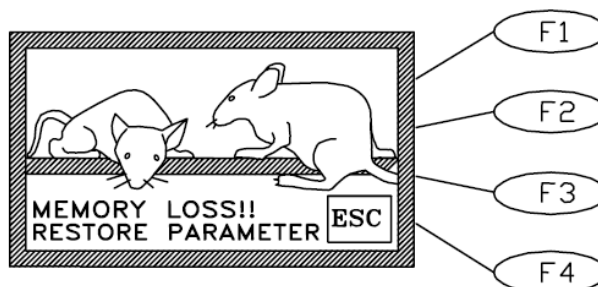

**To replace batteries, first of all switch off the unit and disconnect the mains cable!**



#### **NOTE:**

when the caption **"MEMORY LOSS!!"** appears, the internal memory is lost.

The loss of relevant data can be avoided by **saving data before exiting any experimental session**, see also paragraph 7.1.1-"Memory Full" Message

Always use the same type of batteries for replacement, our part number **E-US 063-1** see paragraph 11-ORDERING INFORMATION.

The batteries are located on the PCB of the controller; take off the bottom panel of the Dynamic Plantar Aesthesiometer Control Unit by removing its four screws.

If needed, wiring diagrams are available; please contact our Customer Support, see paragraph 9.5.

You will notice a mini PCB, assembled on a larger one. On the mini-board there is a small box, marked U3. This 4-pin box contains the batteries and the clock quartz. Extract it with care, by lifting its longer sides with the help of a miniature screwdriver.

Insert the fresh snaphat paying attention to its orientation; its white dot should match the dot on the PCB. A "click" assures you that a proper insertion took place.

Reassemble the bottom panel.

To restore the configuration, you have to restore the standard factory parameters first: depress the **F1** key and keep it depressed for some seconds, then depress together **F4**. The caption **"DEFAULT PARAMETERS RESTORED"** confirms the action.

At this point, set again date and time, see paragraph 7.2 and configuration, see paragraph 5.6.

## **9.2 Touch Stimulator**

If the probe lifting mechanism happens to be accidentally jammed, see paragraph 5.3, a fault message appears on the Electronic Unit display: "POSITION ERROR".

In case the shaft is damaged, its replacement can be carried out successfully only at our factory.

However, in most cases the jamming is caused by particles of animal droppings which stick to the shaft onto which the probe is inserted, thus prevent its its gliding freely up and down.

A cotton swab and a mild detergent can help to clean it, in particular near the upper bearing of the shaft.



In spite the stimulation unit is provided with a protective plastic umbrella, **the upward pushing mechanism might get stuck, due to urine penetrating the same, and crystallizing**, in particular when the Dynamic Plantar Aesthesiometer is used intensely.

When this is the case, the stimulation unit should be serviced at our facility for a thorough cleaning. This can be avoided or at least delayed, by taking the following simple **preventive measures**:

- 1) immediately **wipe away any urine trace** gliding from the protective umbrella onto the stimulation unit, before it leaks in the mechanism;
- 2) **do not leave the stimulation unit below the animal during the habituation phase**. Position the vessel below the animal only during stimulation, and immediately remove it after the test.

### 9.3 Cleaning the Mirror

Dust, fingerprints, traces of animal faeces and urine on the mirror surface may obviously degrade its reflectiveness.

Clean the mirror after each session with mild detergent or a non-alcoholic disinfectant; avoid alcohol which may damage the plastic surface and impair visibility.

### 9.4 Long Inactivity

The instrument does not require any particular maintenance after long inactivity, except cleaning.

Calibration is recommended! See paragraph 8-CALIBRATION.

### 9.5 Customer Support

For any further information you may desire concerning the use and/or maintenance of the Dynamic Plantar Aesthesiometer and accessories, please do not hesitate to contact our **service department** (or our local distributor) either directly or via our support page <http://www.ugobasile.com/support.html>:



**UGO BASILE s.r.l.**

Via G. Di Vittorio 2

21036 GEMONIO – Varese, ITALY





Phone : +39 0332 744574



service@ugobasile.com  
 logistics@ugobasile.com  
 sales@ugobasile.com

**Before sending any instrument to our factory for repair**, please contact our logistics department to obtain a return authorization number (RMA) and shipping/packing instructions.

We may not be held responsible for damages during transport due to poor packing; whenever possible, please use the original packing.

## 10 INSTRUMENT SPECIFICATIONS

### Operation

|  |  |
|--|--|
| Power Requirement                        | Universal mains 85-264 VAC, 50-60Hz  |
| Commands                                 | via soft-buttons   |
| Read-out                                 | multifunction graphic display  |
| Print-out                                | via optional thermal MiniPrinter or panel-mount printer                          |
| Starting                                 | via keys on the I.R. Vessel. Additional key on the Controller                    |
| Force Range                              | 0.5 to 50 grams<br>in 0.1g steps (from 0.5 to 5g) and 0.5g steps (from 5 to 50g) |
| Force Increasing Rate<br>( <i>ramp</i> ) | adjustable in the interval 1 to 50 seconds, in 1 s steps                         |
| Latency Time                             | displayed on the graphic display, in 0.1s steps                                  |
| Connection to PC                         | via USB  |
| Data Portability to PC                   | Via USB pen drive provided   |
| Calibration                              | via calibration weights provided   |
| Operating Temperature                    | 10° to 40° C   |
| Sound Level                              | negligible   |

### Physical

|                    |                         |
|--------------------|-------------------------|
| Total Weight       | 12Kg                    |
| Shipping Weight    | 18.5Kg approx.          |
| Dimensions         | 85x40x35 cm (assembled) |
| Packing Dimensions | 98x49x47cm              |

### Warranty

|          |  |
|----------|--|
| Warranty | Dynamic Plantar Aesthesiometer is covered by a 24-month warranty |
|----------|--|

## 11 ORDERING INFORMATION

### 37450 **Dynamic Plantar Aesthesiometer**, standard package, consisting of:

- 37450-001** Microprocessor controlled electronic unit
- 37400-002** Touch Stimulator, complete with probe actuator and adjustable angled-mirror
- 37000-003** Large Platform
- 37400-327** Supporting column (4)
- 37000-006** Modular Animal Enclosure, with lids and spacers (No. 3 Modules M-S 085)
- 37450-005** Large Framed Perforated Metal Sheet
- 37450-321** Plastic Case lodging
  - 2 Filaments (with umbrella), 2 Calibration Weights, 1 hex. Wrench 1.25
- E-AU 041** Memory Key, including the following:
  - 37450-302** Instruction Manual
  - 52050-12** CUB Data Acquisition Software Package
- E-WP 008** Mains Cable
- E-FF 002** Set of 2 fuses 2A 6.3x32
- 52010-323** USB cable

### 11.1 Spare parts

- 37400-330** Spare filament, with protection umbrella
- E-US 063-1** Battery Snaphat type M4T32-BRI2SH1
- M-S 085** Replacement Cage Module

### 11.2 Optional

- 37450-278** Additional Stimulation Base, complete with perforated metal sheet and animal enclosure
- 37100** Set of 2 Durham Holders for Orofacial Stimulation (see paragraph 5.5)
- 37000-145** Panel-Mount Printer (see also paragraph 3.2)
- 57145** MiniPrinter (see also paragraph 3.3 and 11.3)
- 37400-305** Package of 10 Heat Sensitive Paper Rolls (58 mm paper width, diam. 30 mm roll)

## 11.3 Thermal MiniPrinter

The Mini-Printer 57145 is a thermal array device, for easy connection to the 37450 Dynamic Plantar Aesthesiometer, and other Ugo Basile devices, to print experimental data on its 58mm wide paper Cat. 37400-305.

It is complete with connection cable 7178.

57145 features:

- **very** quiet printing
- **easy** paper loading
- fast **print-out** of several information strings



## 12 BIBLIOGRAPHY

### 12.1 Papers Mentioning UB Dynamic Plantar Aesthesiometer

- R. Lu, A. Schmidtko: “**Direct Intrathecal Drug Delivery in Mice for Detecting In Vivo Effects of cGMP on Pain Processing**” Methods in Molecular Biology 1020: 215-221, 2013
- I.Q. Russe et alia: “**Activation of the AMP-Activated Protein Kinase Reduces Inflammatory Nociception**” Journal of Pain 2, 2013
- J. Btsh et alia: “**Mapping the Binding Site of TRPV1 on AKAP79: Implications for Inflammatory Hyperalgesia**” J. Neuroscience 33 (21): 9184-9193, 2013
- V. Brázda et alia: “**Dynamic Response to Peripheral Nerve Injury Detected by In Situ Hybridization of IL-6 and its Receptor mRNAs in the Dorsal Root Ganglia is not Strictly Correlated With Signs of Neuropathic Pain**” Molecular Pain 9(42), 2013
- V. Shunmugavel et alia: “**Simvastatin Ameliorates Cauda Equina Compression Injury in a Rat Model of Lumbar Spinal Stenosis**” J. Neuroimmune Pharmacology 8 (1): 274-286, 2013
- P.J. Austin et alia: “**G. Chronic Constriction of the Sciatic Nerve and Pain Hypersensitivity Testing in Rats**” JoVE 61, e3393, doi:10.3791/3393, 2012  
<http://www.jove.com/video/3393/chronic-constriction-sciatic-nerve-pain-hypersensitivity-testing>

- O. Coste et alia: **“The p21-activated kinase PAK 5 is involved in formalin-induced nociception through regulation of MAP-kinase signaling and formalin-specific receptors”** Behavioural Brain Research 234 (1): 121-128, 2012
- D. Piomelli et alia: **“Anandamide suppresses pain initiation through a peripheral endocannabinoid mechanism”** Nature NSC, 2010
- M.K. Boettger et alia: **“Differential Effects of Locally and Systemically Administered Soluble Glycoprotein 130 on Pain and Inflammation in Experimental Arthritis”** Arthritis Research & Therapy 12 (R140): 1-9, 2010
- A.L.M. Scott and M.S. Ramer: **“ Schwann Cell p75<sup>NTR</sup> Prevents Spontaneous Sensory Reinnervation of the Adult Spinal Cord”** Brain: 1-12, 2010
- M. Rosemann et alia: **“Microphthalmia, Parkinsonism, and Enhanced Nociception in Pitx3<sup>416insG</sup> Mice”** Mamm Genome 21: 12-27, 2010

## 12.2 Durham Holders for Orofacial Stimulation

- F.G. Garrett, P.L. Durham et alia: **“Validation of a Novel Rat-Holding Device for studying heat- and mechanical-Evoked Trigeminal Nocifensive Behavioral Responses”** J. Orofacial Pain, 26 (4): 336- 344, 2012
- F.G. Garrett, P.L. Durham et alia: **“Development of a novel device for measuring withdrawal latency by thermal stimulation in rodent facial pain models using the Hargreaves Plantar Apparatus”** Poster presented at SFN 2010











ugo basile®

TRANSFORMING IDEAS  
INTO INSTRUMENTS

## CE CONFORMITY STATEMENT

Manufacturer **UGO BASILE srl**  
Address Via G. di Vittorio, 2 – 21036 Gemonio, VA, ITALY  
Phone n. +39 0332 744574  
Fax n. +39 0332 745488

*We hereby declare that*

Instrument. **DYNAMIC PLANTAR AESTHESIOMETER**  
Catalog number **37450**

*is manufactured in compliance with the following European Union Directives  
and relevant harmonized standards*

- *2014/35/UE relating to electrical equipment designed for use within certain voltage limits*
- *2014/30/UE relating to electromagnetic compatibility*
- *2011/65/UE and 2015/863/UE on the restriction of the use of certain hazardous substances in electrical and electronic equipment*

Account Manager

Mauro Uboldi

Nome / Name

October 2018

Date

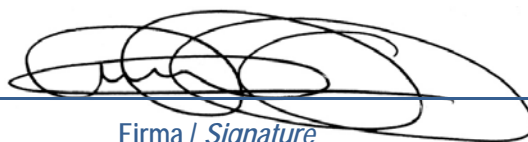

Firma / Signature